

DRILLING, SCREW BITS, SAWING



DIAGER[®]
PROFESSIONAL TOOLS MANUFACTURER

A PROFESSIONNAL RANGE

9 METERS DISPLAY



SAWING

8% Cobalt holesaw, jigsaw blade and reciprocating saw blade.

BOXES

Wide range of boxes including all type of product family, drilling, coring, screwdriving, sawing. Mixed compositions.

SCREW BITS

Bit holder, torsion screw bits for driller and impact driller, long series screw bits.

DRILLING WOOD

Drill bits for hard wood and low density wood, auger bit, flat bit, decking kit, forstner bit and disc plug cutter.

DRILLING METAL

Metal drill bit for steel and alloy steel, TCT HSS drill bit, tap, die, screw extractor

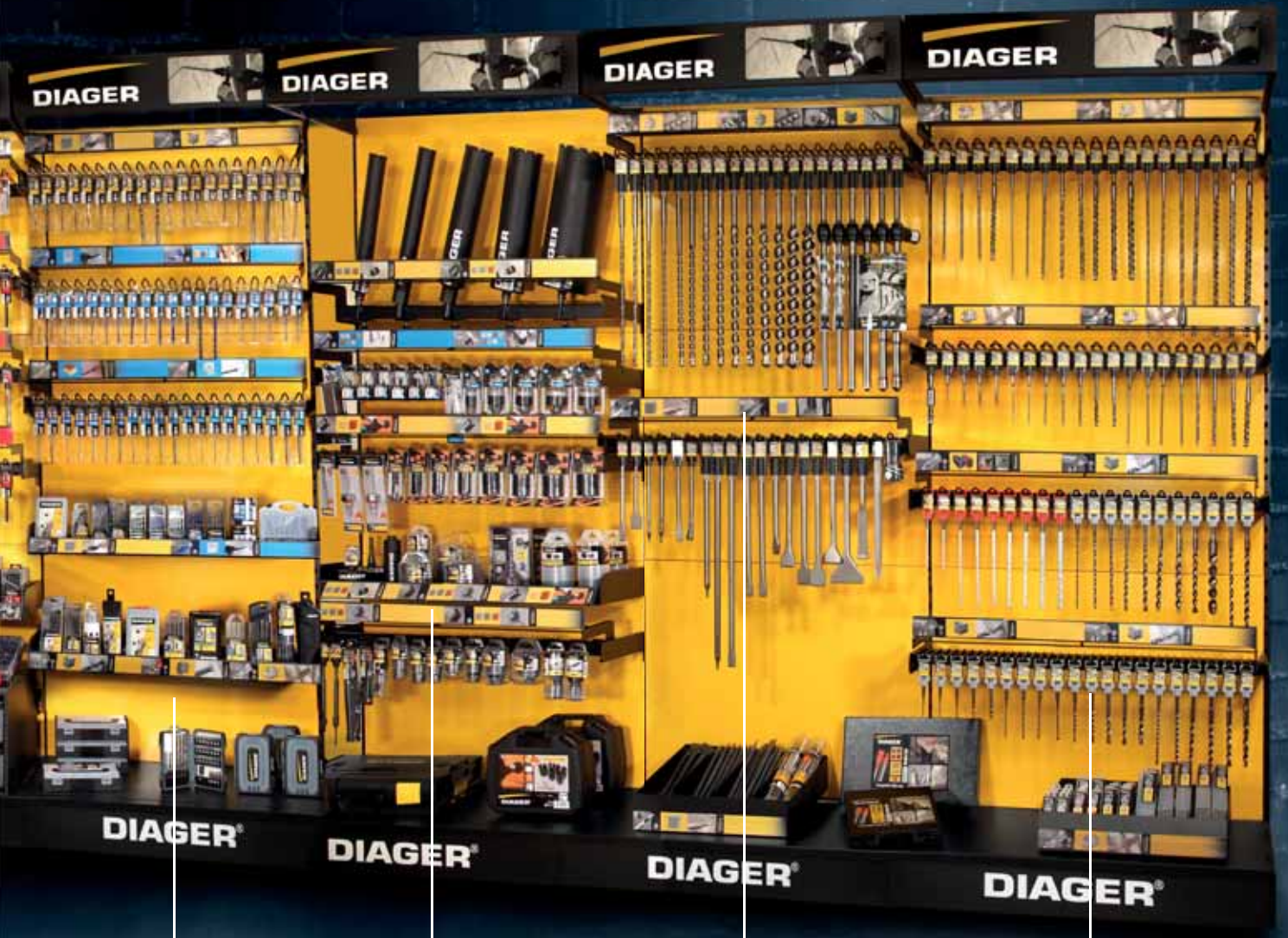

DRILLING SPECIFIC

Specific material drilling, ceramic, glass, gre-ceram, composite, HPL, cement fibre, tile.

CORING

Diamond core bit, drill motor and drilling stand. Diamond core bit and carbide core bit.

DRILLING SDS-MAX

SDS-max drill bit for concrete, reinforced concrete and hard rock. Drill bit up to 4 meters long. Pointed and flat chisels.

DRILLING SDS-PLUS

SDS-plus drill bit for concrete and reinforced concrete, granit, brick, breeze block. Pointed and flat chisels.

DRILLING

Concrete

CONCRETE - HAMMER DRILL BIT

Booster Plus	Ref. 113-157K-157L-157M	16-19
Windows and frames drill bit	Ref. 102-103	20-21
Stop drill bit	Ref. 108	22
4G4	Ref. 112	24
Twister Plus	Ref. 110-108L-108R	26-28
Wallster	Ref. 104	30-31
Granit	Ref. 184	32
Ultimax 646	Ref. 166	34-37
Ultimax	Ref. 168	38-39
Speeduster - Accessories	Ref. 114-114Dplus-161-161Dmax	40-45
Power Max	Ref. 370B>376B-090C>093C	46-51
Crosser	Ref. 165	52

ACCESSORIES

Adapter and Chuck adapter	Ref. 138B-143B-177B	53
Chuck	Ref. 121A-124K	54

TOOL FOR HAMER DRILLS

Helical pointed chisel	Ref. 322-342	58-59
Flat chisel	Ref. 318-343	58
Bush hammer head	Ref. 363	60
Angled bolster	Ref. 348-349	60
Toothed chisel	Ref. 361	60
Jointed chisel	Ref. 329	61
Concrete chasing chisel	Ref. 311-312	61
Brick chasing chisel	Ref. 314	61

TOOL FOR ELECTRIC CONCRETE BREAKER

Pointed chisel	Ref. 310-324-359-354-321-393	62-67
Flat chisel	Ref. 347-320-355-341-351-394	62-67
Spade chisel	Ref. 375	66

DIAMOND

Diamond core bit	Ref. 436A-436B-439B	70-72
Reloading diamond core bit	Ref. Reseg	73
Drill motor	Ref. 350H-351H-356H-398H	74-75
Drilling stand	Ref. 353H-354H-355H	76
Accessories		78-81
Diamond core bit	Ref. 431-432	82-83

CARBIDE CORE BIT

Crusher SDS-plus compatible	Ref. 325C-360-362-374	84-85
Crusher SDS-plus compatible	Ref. 300C-300-330-302	86-87

CONCRETE - STRAIGHT SHANK

Optima3+	Ref. 263	104
Mega	Ref. 226	105
Pro	Ref. 264	106
Flash	Ref. 265	107

Specific

Carbide holesaw - Accessories	Ref. 357L-357M-357A/B/C	88-92
Carbide holesaw - kit - sets	Ref. 3000C/E-3000A/B	93
Blue Ceram	Ref. 426-416-417	94
Grey Ceram	Ref. 423-426E	95
Diamond hole saw - Accessories	Ref. 440C-440A-440B-358A-4400A-440S-416-416A-417	96-101
Multimaterial	Ref. 215	108
Ceramik drill bit	Ref. 245	109
Hard stone & granit drill bit	Ref. 208	109
Cerapro glass and tile drill bit	Ref. 413	110-111
Ceratile tile drill bit	Ref. 400	112
HPL bit	Ref. 201	113
Scribing iron	Ref. 403	115
Carbide claw	Ref. 407	115
Driving bolt	Ref. 300-301	116

Special driller

Hexa, wood drill bit	Ref. 781-981	114
-----------------------------	--------------	------------

HSS-Metal

5% Cobalt drill bit	Ref. 731-700	122-123
HSS-G3 drill bit	Ref. 702-703	124-125
Pro drill bit	Ref. 729-726-735-713-712-715	126-129
Roll forged drill bit	Ref. 750	130
5% cobalt TIALN Step drill bit	Ref. 500B-501B-502B	132-133
Step drill bit	Ref. 511B-512B-513B	134-135
Tap	Ref. 867	136
Screw extractor	Ref. U505	137
Contersink	Ref. 504	137
TCT HSS drill bit	Ref. D2409-D2418	138-139

Wood

Auger bit SUPER PRO	Ref. 912-913-941-946-942-943	142-143
Flat bit & Accessories	Ref. 904-906-908	144-145
Forstner Woodmax bit	Ref. 934	146
Formwork drill bit	Ref. 723M-722M	147
Depth adjuster collars	Ref. 938C	145
Wood countersink	Ref. 939	145
4 points drill bit - 4 Wood	Ref. 910	148
3 points drill bit	Ref. 915	149
Decking kit	Ref. 902-911	150-151

INFORMATIONS

Company presentation - RSE	6-11
Symbols, packaging legends, common	12-13
Drilling concrete guide	14-15
Certificates, Labels, Trophies	29
Electric concrete breaker & attachments compatibility	67
Drilling core guide	69
Coring advices	77
Speed of drilling rotation	154-155
Screw bits manual	156-159
Holesaws manual	186-187
Jigsaw and reciprocating blade manual	194-201
Textile	216
Services	226
Social medias	227

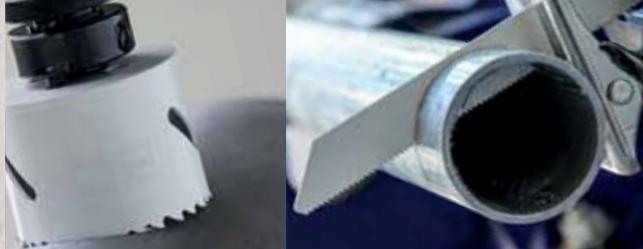

SAWING

HOLESAW

Bi-Metal holesaw 8%	Ref. 650	186-188
Bi-Metal holesaw	Ref. 654	189
Accessories	Ref. 651-652	190-191

JIGSAW BLADE

Wood	Ref. L000W > L101W	202-206
Specific	Ref. L012S	207
Metal	Ref. L000M > L102M	207-209

RECIPROCATING SAW BLADE

Wood	Ref. L200W > L202W - L204S	210-211
Specific	Ref. L200S > L206S	211-213
Metal	Ref. L200M > L206M	213-215
Accessories	Ref. 680	210



SETS

Concrete	114-115
Specific	116-117
Metal	138-139
Wood	152-153
Screwdriving	180-183
Holesaw	192-193



MERCHANDISING

Display 9 meters, range pro XXL	2-3
SDS-plus concept	33
Demolition concept	57
Diamond concept	68
Concrete concept	102-103
HSS concept	129
Screw bits	184-185
Information about sales place	217
Drill center	218-219
Concept store	220-221
Bottom of shelf low sales shelf	222-223
Sales animation	223
List of furnitures	224-225



SCREW BITS

IMPACT BLUE SHOCK SCREW BITS

Phillips	Ref. U610PH	160-161-170
Pozidriv	Ref. U612PZ	160-161-170
Torx	Ref. U613T	160-161-170
Hexagonal	Ref. U615HEX	162
Square	Ref. U617SQ	162
Bit holder	Ref. U621B	162

PRO SCREW BITS

TORSION SCREW BITS

Phillips	Ref. U640PH	164-171
Pozidriv	Ref. U642PZ	164-171
Torx	Ref. U643T	165-171
Slotted	Ref. U641PL	165

REDUCED SECTION QUALITY SCREW BITS

Phillips	Ref. U620PH	166
Pozidriv	Ref. U622PZ	166
Torx	Ref. U623T	167
Torx Tamper	Ref. U624TT	167
Hexagonal	Ref. U625HEX	167

QUALITY SCREW BITS

Torx Tamper	Ref. U624TT	168
Hexagonal	Ref. U625HEX	168
Carré	Ref. U627SQ	168
Spanner	Ref. U628SP	168

STAINLESS STEEL SCREW BITS

Phillips	Ref. U650PH	164
Pozidriv	Ref. U650PZ	164
Torx	Ref. U650T	164
Slotted	Ref. U650PL	164

ACCESSORIES

Bit-holders	Ref. U634-U639-U648-U638-U626-U628-U629-U635	172-175
Stopvis	Ref. 627	175
90° angle driver	Ref. 637	176
Handle 1/4" with flexible shaft	Ref. 644	176
Quick lock handle 1/4"	Ref. 645	178
Telescopic handle 1/4"	Ref. 646	178
Surface protection socket	Ref. U601S	179
Pro magnetic socket	Ref. U600-U603	179

KEY MILESTONES FOR THE COMPANY

1933

Brothers Robert and Jean Defougères develop the application of tungsten carbide for machining moulds for plastic injection



1968

The company sets up in Poligny, in Jura, in a 280 m² facility with 15 workers



1998

Launch of the Booster drill bit

1953

Pierre Defougères takes over and expands the range with carbide drill bits, and sets up his workshop in Paris



1995

Launch of the ULTIMAX drill bit



1993

ISO 9002 (ISO 9001) certification



2013

Acquisition of a company manufacturing screwdriver bits in Germany: USH

2020

AFNOR 26000 experienced level CSR label



2018

1,600 m² extension for the Hammer drill bit workshop

2015

Launch of the depth stop drill bit

2022

Diager's commitment deepens with a CSR Charter

2017

Launch of the Wallster drill bit



1999
A 3,500 m² shipping centre
and 600 m² of offices



2000
ISO 14001
certification



2001
Launch of the
Twister drill bit

2003
Diager becomes a founding
member of Made In Jura



2004
Acquisition of a company
manufacturing diamond
core bits



2009
Implementation of
the stacker crane

2012
OFG certification

2011
Creation of a new subsidiary,
DIAMEX, located in Mexico

2009
Launch of
diamond tools



2011
Launch of a new
glass drill bit

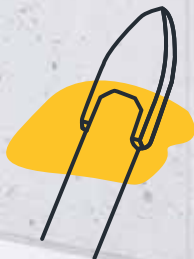



2010
Launch of the
multi-materials
drill bit



2011
Launch of the helical
pointed chisel



2023
70 years

-  Tools
-  Expansions
-  Certifications



François Defougères

DIAGER Group CEO

**Our "Raison d'être" ;
to supply tools in a sustainable manner.**

Since time immemorial, the production of high-performance tools has been a source of progress, has driven humankind's development and strengthened social ties between communities. Diager is humbled to contribute to this historical link through our commitment to developing high-quality, practical and robust tools. I would like to combine this with a Responsible dimension, mindful of Social, Environmental and Economic balance.

All the elements for a CSR-oriented policy are in place, and we have built on these commitments to ensure our companies have reached "ISO 26000 experienced level". We have published our CSR charter, consolidated our governance model, enhanced our regional partnerships and freed up resources to undertake multiple transitional actions. I encourage you to read our charter on our website. It summarises our commitments, guides our choices and consolidates our strategic vision.

We are here for the long haul: we will soon be turning 70 and the company is looking good for its age!

We have written this wonderful story with our customers and suppliers who put their trust in us, with our employees who commit themselves on a daily basis, and with our "stakeholders" who provide a favourable environment in which to thrive.

We still have many more chapters to write and to do so, our strategy for the years to come is not short of ambition!

We intend to be Responsible and Committed!

ECONOMIC PILLAR

DIAGER is developing its industrial DNA by renewing its production facilities, its products and its services.

By making a commitment and ensuring the company's longevity...

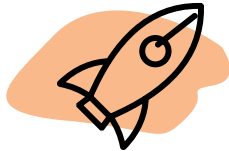

INNOVATIONS

DIAGER products must withstand extreme conditions of use, in concrete, rebar, as well as in granite, ceramic, hard rock, and composite materials. With 70 years of experience, DIAGER designs innovative tools and addresses users' needs by developing the design, the geometries and the raw materials used, etc.



DEVELOPMENT

In the space of 10 years, sales have risen by 58% and €22 million have been invested in new production lines and the latest state-of-the-art equipment. Over the last 10 years, production capacity has also doubled for hammer drill bits.

DIAGER'S COMMITMENT



LEAN MANAGEMENT

On our production lines to:

- DRIVE OUT WASTE FROM OPERATIONAL PROCESSES
- SPEED UP INNOVATION
- IMPROVE COLLABORATION



TRADE

Exports account for 47% of DIAGER's revenue. With products marketed in 80 countries and with more than 4,500 customers. DIAGER is committed to its customers with sales events, demonstrations and product training courses for its end users.

SOCIAL & CORPORATE PILLAR

DIAGER is committed to quality of work life, fair trading relations and solidarity.

...while considering and respecting all of its stakeholders...



INTERNAL COMMUNICATION

DIAGER communicates with its employees through screens and an in-house newsletter about corporate life, CSR actions, key figures, customer visits, etc. DIAGER raises awareness about social, corporate and environmental impacts through the UN's 17 Sustainable Development Goals.



WELL-BEING

DIAGER fosters a policy based on attentive listening and action, to enable every employee to lead a fulfilling personal, social and cultural life. Example: massage sessions, social support service, the right to disconnect, a point of contact for "moral, sexual and sexist harassment".



EAT/MOVE

DIAGER is committed to the health of its employees, and is certified under France's National Health and Nutrition Programme. DIAGER offers sports sessions, relaxation massages, sporting activities (hikes, trail runs, company challenges, etc.), and nutritional advice.



SOLIDARITY

DIAGER listens to its employees and its stakeholders. DIAGER offers a social and legal assistance service, support to any employee having personal difficulties or problems. DIAGER organises solidarity days such as Movember and Pink October.

GENDER EQUALITY index

DIAGER is mindful of equal treatment between men and women, and is committed to implementing all necessary measures to ensure this parity is upheld.



REGIONAL ROOTS

DIAGER is committed to the local economy, through promotion, distribution and incentive actions. DIAGER provides material, human and financial backing in favour of cultural, sporting, artistic and educational projects.

ENVIRONMENTAL PILLAR

DIAGER is committed to frugality and considers the impact of every investment measure.

...by joining the revolution for conserving resources.



OWN PRODUCTION

The 1,000 m² of solar panels installed on our buildings produce 7% of our total consumption.

DIAGER'S COMMITMENT

100% LED

In 2022, the LED project was completed at DIAGER. All our buildings have LED lighting with motion and brightness sensors. When the room is sunlit or empty, the light turns off.



BIODIVERSITY

DIAGER is committed to protecting terrestrial ecosystems, practices late mowing and hosts hives on its land. DIAGER is a partner in a unique development project for a UNESCO site, a laboratory for landscape professions combining experimentation, circular economy, and education.



PACKAGING

DIAGER is making developments to its packaging with the goal of reducing waste and petroleum components. DIAGER encourages recycling and a circular economy.



RESPONSIBLE PURCHASING

DIAGER takes CSR criteria into consideration when selecting its suppliers and partners. These choices create sustainable value, reduce our environmental impact, promote ethical sourcing and engage our suppliers.



Symbols

Materials

Masonry

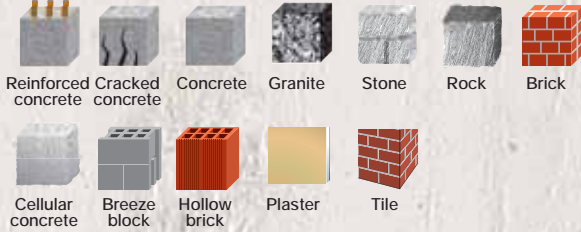

Wood



Metals



Specifics



Insulation

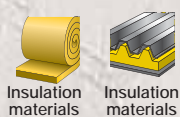

Diamond Tools

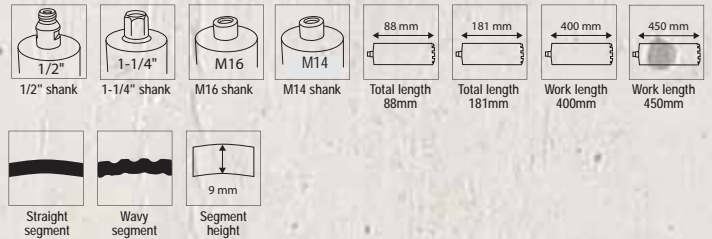

Metal drill bits

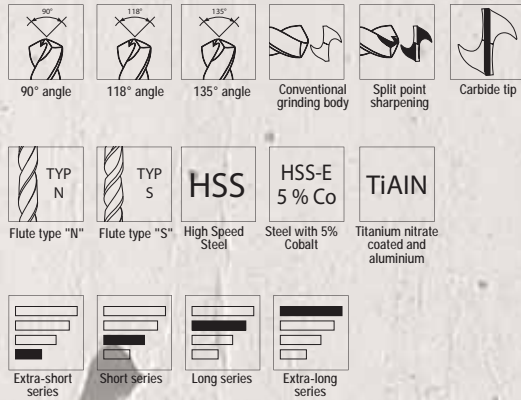

Taps



Motors



Use



Shanks

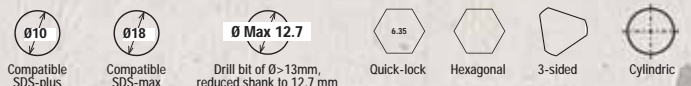

Security



Packaging Legends

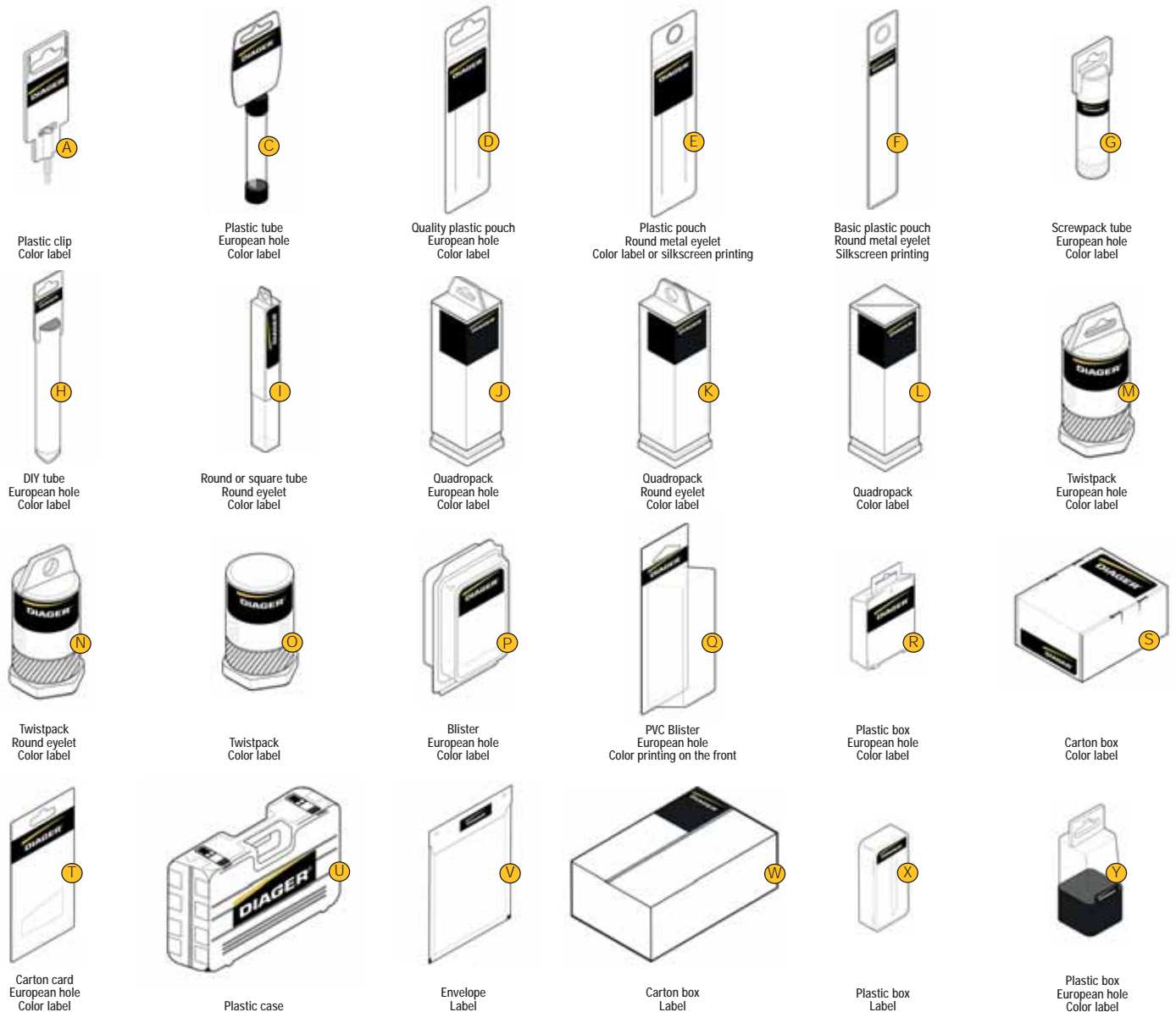

To ensure the fastening of the fasteners in time, it is advisable to put the european hole type fasteners on a double spindle, especially for heavy products.

Prüfgemeinschaft

The PGM is an independent association which certifies hammer and straight shank drill bits since 1978. He stays up the standards, and, checks products and policies of quality monitoring of the manufacturers. Drill bits have to meet the requirements of a strict specifications with the aim of allowing safe anchorings. These controls carry among others, on the diameter, the centring of the carbide tip, the straightness of drill bits. Certified drill bits are stamped with the PGM logo with the manufacturer number.





Common

Ø	Tool's diameter
Øint.	Inside diameter
Øext.	Outside diameter
Øatt.	Shank diameter
ØxP.	Diameter x Depth
ØxPas	Diameter x Metrical Thread
WL	Working length
TL	Total length
L200 x 340	WL x TL
Larg.	Tool's width
Ep.	Thickness
L	Length
h	Tool height
N.S	Segments quantity
ml	Volume (in ml)
Coul	Colors
Qt.	Quantity
UC	Multiple of order
Pack	Packaging
Pcs	Quantity per set
mm/tpi	Quantity of teeth

Drilling concrete and specifics guide

Ref.	Features	Attachment compatible	Origin & Standards	Benefits	Page	Reinforced concrete	Concrete	Granit	Stone, Rock	Brick	Cellular concrete	Breeze block	Hollow brick
113	Booster	SDS-plus	 	<ul style="list-style-type: none"> • Drill rebar • Perfectly round and calibrated hole • Drills without cracking the concrete 	16-19	Optimal	Optimal		Optimal				
102	Windows & Frame drill bit	SDS-plus	 	<ul style="list-style-type: none"> • Doors and windows frame applications • Perfectly round and calibrated hole • Elasticity resistance 	20-21	Optimal	Optimal		Optimal			Occasional	
108	Stop drill bit	SDS-plus	 	<ul style="list-style-type: none"> • Perfect for fast volume drilling • Depth control • Drill rebar 	22	Optimal	Optimal		Optimal				
112	4G4	SDS-plus	 	<ul style="list-style-type: none"> • Spdd • Longer life time 	24		Optimal		Optimal			Occasional	
110	Twister	SDS-plus	 	<ul style="list-style-type: none"> • Spdd • Longer life time 	26-28		Optimal		Optimal			Occasional	
104	Wallster	SDS-plus	 	<ul style="list-style-type: none"> • Perfect design for hollow bricks • Perfect anchoring of plugs 	30-31						Optimal	Optimal	Optimal
184	Granit	SDS-plus	 	<ul style="list-style-type: none"> • Drilling into granit from class 1 to 3 	32		Optimal	Optimal	Optimal				
166	Ultimax 646	SDS-max	 	<ul style="list-style-type: none"> • Rebar drilling • Longer life time • Avoid risk of blocking • Perfectly round and calibrated hole 	36-37	Optimal	Optimal		Optimal				
168	Ultimax	SDS-max		<ul style="list-style-type: none"> • Rebar drilling • Longer life time • Avoid risk of blocking • Perfectly round and calibrated hole 	38-39	Optimal	Optimal		Optimal				
114 161	Speeduster 3T Speeduster 646	SDS-plus SDS-max	 	<ul style="list-style-type: none"> • Rebar drilling • Work without dust • Retroactive rebar connection 	42-45	Optimal	Optimal		Optimal			Occasional	
373B	Power-Max	SDS-max		<ul style="list-style-type: none"> • Big diameter • Deep drilling • Modular system 	46-51		Optimal		Optimal			Occasional	
165	Crosser	SDS-max		<ul style="list-style-type: none"> • Shipyards of renovation, install electrical enclosures... • Deep drilling in crossing • Important diameter 	52		Optimal		Optimal			Occasional	
322 342	Helical pointed chisel	SDS-plus SDS-max		<ul style="list-style-type: none"> • Effortless drilling • Anti-lock 	58-59		Optimal		Optimal			Occasional	
318 343	Flat chisel	SDS-plus SDS-max		<ul style="list-style-type: none"> • Intensive work • Robust and power of optimal typing 	58		Optimal		Optimal			Occasional	
310 324 359 354 393	Pointed chisel	For electric breaker		<ul style="list-style-type: none"> • For electric breaker • Intensive work • Robust and power of optimal typing 	62-67		Optimal		Optimal			Occasional	
320 355 347 341 394	Flat chisel	For electric breaker		<ul style="list-style-type: none"> • Intensive work • Robust and power of optimal typing 	62-67		Optimal		Optimal			Occasional	

 Optimal

 Occasional

WARNING: The user of our products is the only responsible for the structural consequences of drilling concrete rebars. It is necessary to consult specialized engineers if a structural part is concerned.

Ref.	Features	Attach-ment	Origin & Standards	Benefits	Page	Concrete	Granit	Stone, Rock	Brick	Cellular concrete	Breeze block	Hollow brick	Plaster	Low density wood	Steel	Marble	Slate	Ceramik	Tiles up to 5th class	No-tempered glass	Cement fibre, Composite, HPL	Ice	Plastic
431 432	Diamond core bit	M16		<ul style="list-style-type: none"> • Electrical installations (installation of box, box...) • Net hole • Versatility • Robustness 	82-83																		
325C 360	Crusher Carbide core bit	SDS-plus		<ul style="list-style-type: none"> • Passage of electrical equipment with diameters important • Performance and robustness 	84-85																		
300C 300	Carbide core bit	SDS-max		<ul style="list-style-type: none"> • Sanitary works and renovation • Performance and robustness 	86-87																		
357L	Carbide hole saw	Hexagonal SDS-plus		<ul style="list-style-type: none"> • Large clearance of chip • Fast drilling • Integrated adapter to change of hole saw in one easy step • Quick ejection of core 	88-92																		
426 423	Blue ceram Grey Ceram Diamant	M14 Hexagonal		<ul style="list-style-type: none"> • Drilling of sandstone class 4 and 5 • Holes clean, precise and without the glare 	94-95																		
440C	Diamond hole saw	M14 Hexagonal		<ul style="list-style-type: none"> • Fast drilling • Long life • Dry drilling 	96-101																		
263	Optima 3+	Straight shank		<ul style="list-style-type: none"> • Self centering tip • Round and calibrated hole for perfect anchoring 	104																		
226	Mega	Straight shank		<ul style="list-style-type: none"> • Intensive use • Longevity and performance 	105																		
264	Pro	Straight shank		<ul style="list-style-type: none"> • Speed 	106																		
265	Flash	Straight shank		<ul style="list-style-type: none"> • For cordless drills • More than 20% battery life time 	107																		
215	Multi-materials	Straight shank		<ul style="list-style-type: none"> • Versatile 	108																		
245	Ceramik	Straight shank		<ul style="list-style-type: none"> • Drilling of ceramics • Speed and cleanliness of drilling 	109																		
208	Hard stone & granit	Straight shank		<ul style="list-style-type: none"> • The work of marbrier (installation of kitchen, bathroom...) • Durability and resistance 	109																		
400	Ceratile	Straight shank		<ul style="list-style-type: none"> • Speed of drilling and great versatility 	112																		
201	HPL drill bit	Straight shank		<ul style="list-style-type: none"> • Install insulating facade, kitchen, false ceiling... • Speed, cleanliness & longevity 	113																		

3 cutters technology



all products 3 cutters technology



Special REINFORCED CONCRETE *booster*_{plus} compatible SDS-plus - ref.113



WINDOWS & FRAME drill bit - compatible SDS-plus - ref.102



Bit with stop - compatible SDS-plus - ref.108



RESISTANCE TO OVERHEATING



The solid monobloc carbide tip, is inserted and brassed with copper, resistant to over 1000°C temperature raise

HAMMERING EFFECT

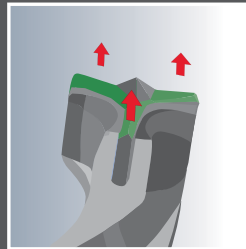

3X 135° edges, combine the most efficient drilling without cracking the concrete around

PRECISION

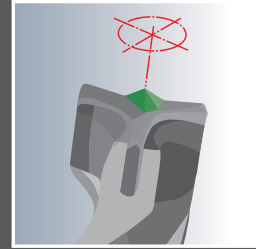

The self centering tip design, drives the bit straight

TRAJECTORY CONTROL

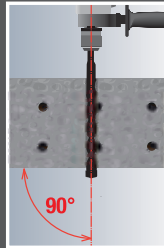

PERFECT HOLE, PERFECT ANCHORING



Answers to all world technical standards agreements

BETTER DUST REMOVAL CAPACITIES

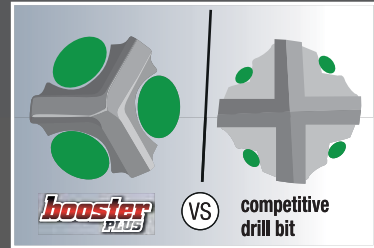

Its design offers the largest dust removal on its market

SPECIAL REINFORCED CONCRETE

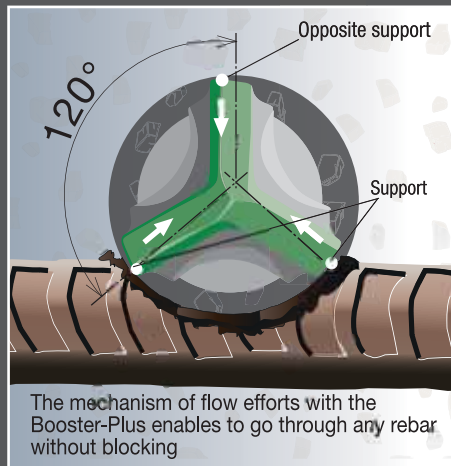

Ref. 113

Booster Plus *booster* PLUS

Hammer drill bit 3 cutting edges compatible SDS-plus

High performance drill bit for drilling concrete and reinforced concrete.



Reinforced concrete, Concrete, Stone, Brick

+

• DRILL REINFORCED CONCRETE

Features

- Monobloc carbide tip 3 cutting edges.
- Angle tip 150°.
- Self centering tip.

Benefits

- Drilling in all types of concrete.
- Accuracy in starting the hole.
- Perfectly round and calibrated hole.
- Fast dust evacuation.
- Resistance and long life.

Shank Hammer drill



Compatible SDS-plus



VIDEO DEMO



ALL SETS PAGES 114-115

x7



113D

x5



104B

x5



115C

x10



072B

Ø	WL	TL	Ref.	Gencod	Qty
L 50 x 110					
5	50	110	113D05L0110	3336600110694	1
6	50	110	113D06L0110	3336600029385	1
6.5	50	110	113D06.5L0110	3336600051577	1
8	50	110	113D08L0110	3336600029392	1
10	50	110	113D10L0110	3336600055728	1
L 100 x 160					
5	100	160	113D05L0160	3336600110700	1
5.5	100	160	113D05.5L0160	3336600185807	1
6	100	160	113D06L0160	3336600029408	1
6.5	100	160	113D06.5L0160	3336600051584	1
7	100	160	113D07L0160	3336600077904	1
8	100	160	113D08L0160	3336600029415	1
9	100	160	113D09L0160	3336600093560	1
10	100	160	113D10L0160	3336600029422	1
12	100	160	113D12L0160	3336600029439	1
13	100	160	113D13L0160	3336600093591	1
14	100	160	113D14L0160	3336600077911	1
15	100	160	113D15L0160	3336600110717	1
16	100	160	113D16L0160	3336600110762	1
L 150 x 210					
5.5	150	210	113D05.5L0210	3336600185814	1
6	150	210	113D06L0210	3336600029446	1
6.5	150	210	113D06.5L0210	3336600093607	1
7	150	210	113D07L0210	3336600077928	1
8	150	210	113D08L0210	3336600029453	1
9	150	210	113D09L0210	3336600093614	1
9.5	150	210	113D09.5L0210	3336600168480	1
10	150	210	113D10L0210	3336600029460	1
12	150	210	113D12L0210	3336600029477	1
13	150	210	113D13L0210	3336600093638	1
14	150	210	113D14L0210	3336600077935	1
15	150	210	113D15L0210	3336600110724	1
16	150	210	113D16L0210	3336600084155	1
18	150	210	113D18L0210	3336600084162	1
20	150	210	113D20L0210	3336600084179	1



Black plastic clip

Ø	WL	TL	Ref.	Gencod	Qty
L 200 x 260					
6	200	260	113D06L0260	3336600154025	1
6.5	200	260	113D06.5L0260	3336600154032	1
8	200	260	113D08L0260	3336600154049	1
9.5	200	260	113D09.5L0260	3336600168497	1
10	200	260	113D10L0260	3336600154056	1
12	200	260	113D12L0260	3336600154063	1
14	200	260	113D14L0260	3336600154070	1
16	200	260	113D16L0260	3336600162723	1
18	200	260	113D18L0260	3336600162730	1
20	200	260	113D20L0260	3336600162747	1
L 250 x 310					
6	250	310	113D06L0310	3336600084186	1
6.5	250	310	113D06.5L0310	3336600059443	1
7	250	310	113D07L0310	3336600077942	1
8	250	310	113D08L0310	3336600029484	1
9	250	310	113D09L0310	3336600093645	1
10	250	310	113D10L0310	3336600029491	1
12	250	310	113D12L0310	3336600029507	1
13	250	310	113D13L0310	3336600093676	1
14	250	310	113D14L0310	3336600077959	1
15	250	310	113D15L0310	3336600110731	1
16	250	310	113D16L0310	3336600054264	1
18	250	310	113D18L0310	3336600054271	1
20	250	310	113D20L0310	3336600054288	1
L 400 x 460					
8	400	460	113D08L0460	3336600093034	1
10	400	460	113D10L0460	3336600054295	1
12	400	460	113D12L0460	3336600054301	1
14	400	460	113D14L0460	3336600054318	1
16	400	460	113D16L0460	3336600054325	1
18	400	460	113D18L0460	3336600054332	1
20	400	460	113D20L0460	3336600054349	1
L 550 x 610					
8	550	610	113D08L0610	3336600099173	1
10	550	610	113D10L0610	3336600054387	1
12	550	610	113D12L0610	3336600054394	1
14	550	610	113D14L0610	3336600054400	1
16	550	610	113D16L0610	3336600054417	1
18	550	610	113D18L0610	3336600054424	1
20	550	610	113D20L0610	3336600054431	1

Ref. 157K Hammer drill bit 3 cutting edges compatible SDS-plus pack 6 pcs

Ø	WL	TL	Ref.	Gencod	Qty
L 50 x 110					
6	50	110	157KD06L0110	3336600152359	1
L 100 x 160					
6	100	160	157KD06L0160	3336600152366	1
8	100	160	157KD08L0160	3336600152397	1
10	100	160	157KD10L0160	3336600152427	1
12	100	160	157KD12L0160	3336600152458	1
14	100	160	157KD14L0160	3336600152489	1
16	100	160	157KD16L0160	3336600152519	1
L 150 x 210					
8	150	210	157KD08L0210	3336600152403	1
10	150	210	157KD10L0210	3336600152434	1
12	150	210	157KD12L0210	3336600152465	1
14	150	210	157KD14L0210	3336600152496	1
16	150	210	157KD16L0210	3336600152526	1
L 250 x 310					
16	250	310	157KD16L0310	3336600152533	1



Ref. 157L Hammer drill bit 3 cutting edges compatible SDS-plus pack 12 pcs

Ø	WL	TL	Ref.	Gencod	Qty
L 50 x 110					
5	50	110	157LD05L0110	3336600152540	1
6	50	110	157LD06L0110	3336600152564	1
8	50	110	157LD08L0110	3336600152595	1
L 100 x 160					
5	100	160	157LD05L0160	3336600152557	1
6	100	160	157LD06L0160	3336600152571	1
8	100	160	157LD08L0160	3336600152601	1
10	100	160	157LD10L0160	3336600152632	1
12	100	160	157LD12L0160	3336600152663	1
L 150 x 210					
6	150	210	157LD06L0210	3336600152588	1
6.5	150	210	157LD06.5L0210	3336600164727	1
8	150	210	157LD08L0210	3336600152618	1
10	150	210	157LD10L0210	3336600152649	1
12	150	210	157LD12L0210	3336600152670	1
L 200 x 260					
6	200	260	157LD06L0260	3336600162693	1
8	200	260	157LD08L0260	3336600158818	1
10	200	260	157LD10L0260	3336600159068	1
12	200	260	157LD12L0260	3336600158825	1
14	200	260	157LD14L0260	3336600197909	1
16	200	260	157LD16L0260	3336600162709	1
L 250 x 310					
8	250	310	157LD08L0310	3336600152625	1
10	250	310	157LD10L0310	3336600152656	1
12	250	310	157LD12L0310	3336600152687	1
L 400 x 460					
8	400	460	157LD08L0460	3336600183346	1
10	400	460	157LD10L0460	3336600159075	1
12	400	460	157LD12L0460	3336600159082	1
L 550 x 610					
10	550	610	157LD10L0610	3336600159099	1
12	550	610	157LD12L0610	3336600159105	1



Ref. 157M Hammer drill bit 3 cutting edges compatible SDS-plus pack 25 pcs

Ø	WL	TL	Ref.	Gencod	Qty
L 50 x 110					
5	50	110	157MD05L0110	3336600152694	1
6	50	110	157MD06L0110	3336600152717	1
8	50	110	157MD08L0110	3336600152748	1
L 100 x 160					
5	100	160	157MD05L0160	3336600152700	1
6	100	160	157MD06L0160	3336600152724	1
8	100	160	157MD08L0160	3336600152755	1
10	100	160	157MD10L0160	3336600152786	1
12	100	160	157MD12L0160	3336600152816	1
L 150 x 210					
6	150	210	157MD06L0210	3336600152731	1
8	150	210	157MD08L0210	3336600152762	1
10	150	210	157MD10L0210	3336600152793	1
12	150	210	157MD12L0210	3336600152823	1
L 250 x 310					
8	250	310	157MD08L0310	3336600152779	1
10	250	310	157MD10L0310	3336600152809	1



Ref.
102

Booster Plus windows frame

Windows frame hammer drill bit 3 cutting edges compatible SDS-plus

SDS-plus drill bit 3 cutting edges flex system for windows frame.



• BENDING STRENGTH

Features

- Monobloc carbide tip 3 cutting edges.
- Angle tip 150°.
- Self centering tip.
- Reinforcement zone.

Benefits

- Drilling in all types of concrete.
- Accuracy in starting the hole.
- Perfectly round and calibrated hole.
- Fast dust evacuation.
- Resistance and long life.

Applications

- Installation of window frames.



Reinforced concrete, Concrete, Stone, Brick, Breeze block

Shank Hammer drill

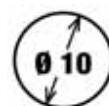

Compatible
SDS-plus



Black plastic clip

Ø	WL	TL	Ref.	Gencod	Qty
L 150 x 210					
6	150	210	102D06.L0210	3336600157163	1
6.5	150	210	102D06.5L0210	3336600157187	1
L 200 x 260					
6	200	260	102D06.L0260	3336600157170	1
6.5	200	260	102D06.5L0260	3336600157194	1
L 250 x 310					
6.5	250	310	102D06.5L0310	3336600169586	1

FLEX

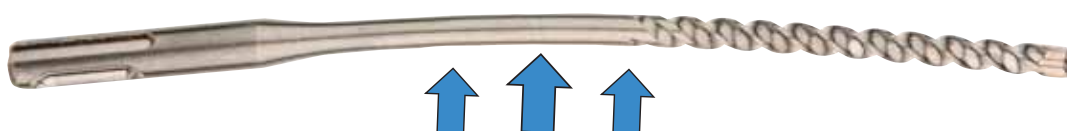

Ref.
103

Windows frame hammer drill bit 3 cutting edges compatible SDS-plus

SDS-plus drill bit 3 cutting edges flex system for windows frame - pack 12 pcs.



Black plastic clip

Ø	WL	TL	Ref.	Gencod	Qty
L 200 x 260					
6.5	200	260	103D06.5L0260	3336600162716	1

APPLICATIONS

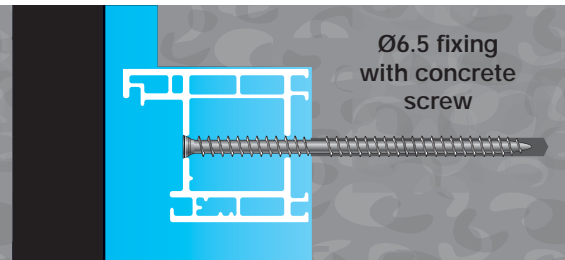
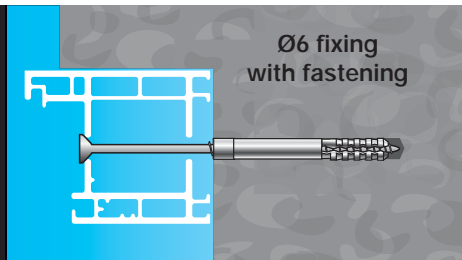
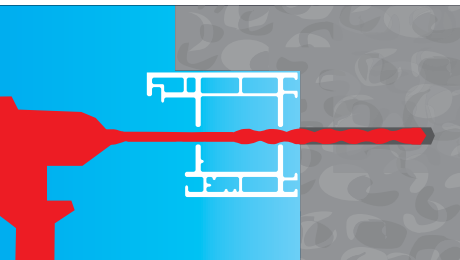

Ref.
108

Booster Plus depth stop

Hammer drill bit 3 cutting edges compatible SDS-plus

SDS+ drill bit 3 cutting edges with depth stop system, special drop in anchors.



• PERFECT HOLES CALIBRATION

Features

- Monobloc carbide tip 3 cutting edges.
- Angle tip 150°.
- Self centering tip.
- Depth stop system.

Benefits

- Drilling in all types of concrete.
- Accuracy in starting the hole.
- Perfectly round and calibrated hole.
- Fast dust evacuation.
- Resistance and long life.

Applications

- Installation of cable trays.
- Fixing in series.



Reinforced concrete, Concrete, Stone, Brick

Shank Hammer drill



Compatible
SDS-plus



Black plastic clip

Ø	WL	TL	Ref.	Gencod	Qty
8	27	110	108D08L0027	3336600181137	1
10	33	110	108D10L0033	3336600184381	1
12	43	130	108D12L0043	3336600184398	1
15	52	160	108D15L0052	3336600181168	1
15	54	160	108D15L0054	3336600184404	1

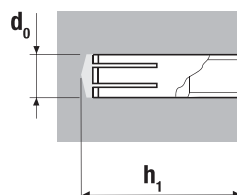

Thread x Lt	d ₀ mm	h ₁ mm
M6x25	8	25
M8x30	10	30
M10x40	12	40
M12x50	15	50
M16x65	20	65

OUR TESTED TOOLS



250,000 HOLES AND 100 TONS OF CONCRETE EACH YEAR

With 2 certified test benches, Diager performs around 250,000 holes each year to carry out checks and tests on its products. 100 tons of concrete are needed for these tests!

Diager ensures that it maintains an impeccable level of quality for its customers, on each of the twenty million parts produced per year in Poligny (Jura).

Ref. 112

4G4 drill bit



Hammer drill bit 4 cutting edges compatible SDS-plus

SDS-plus drill bit made of high quality alloy steel with a premium tungsten carbide 4 cutters tip, guarantees performances even in the hardest concrete.



Concrete, Stone, Brick, Breeze block



LONG LIFE

Features

- Monobloc carbide tip 4 cutting edges.
- 4 evacuation grooves.
- Centering tip.

Benefits

- Long life.
- Fast dust evacuation.
- Torsion resistance.

Shank Hammer drill

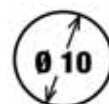

Compatible SDS-plus

Ø	WL	TL	Ref.	Gencod	Qty
L 50 x 110					
5	50	110	112D05L0110	3336600201361	1
5.5	50	110	112D05.5L0110	3336600201347	1
6	50	110	112D06L0110	3336600196155	1
6.5	50	110	112D06.5L0110	3336600201378	1
8	50	110	112D08L0110	3336600196223	1
L 100 x 160					
5.5	100	160	112D05.5L0160	3336600201354	1
6	100	160	112D06L0160	3336600196162	1
6.5	100	160	112D06.5L0160	3336600196896	1
8	100	160	112D08L0160	3336600196230	1
10	100	160	112D10L0160	3336600196278	1
12	100	160	112D12L0160	3336600196322	1
13	100	160	112D13L0160	3336600201392	1
14	100	160	112D14L0160	3336600201408	1
15	100	160	112D15L0160	3336600201415	1
16	100	160	112D16L0160	3336600201439	1
L 150 x 210					
6	150	210	112D06L0210	3336600196179	1
6.5	150	210	112D06.5L0210	3336600196209	1
8	150	210	112D08L0210	3336600196247	1
10	150	210	112D10L0210	3336600196285	1
12	150	210	112D12L0210	3336600196339	1
14	150	210	112D14L0210	3336600196377	1
15	150	210	112D15L0210	3336600201422	1
16	150	210	112D16L0210	3336600196407	1
L 200 x 260					
6	200	260	112D06L0260	3336600196186	1
8	200	260	112D08L0260	3336600196254	1
10	200	260	112D10L0260	3336600196292	1
12	200	260	112D12L0260	3336600196346	1
22	200	260	112D22L0260	3336600201453	1
24	200	260	112D24L0260	3336600201477	1
25	200	260	112D25L0260	3336600201491	1
26	200	260	112D26L0260	3336600201514	1
L 250 x 310					
6	250	310	112D06L0310	3336600196193	1
6.5	250	310	112D06.5L0310	3336600196216	1
8	250	310	112D08L0310	3336600196261	1

Ø	WL	TL	Ref.	Gencod	Qty
10	250	310	112D10L0310	3336600196308	1
12	250	310	112D12L0310	3336600196353	1
14	250	310	112D14L0310	3336600196384	1
16	250	310	112D16L0310	3336600196414	1
18	250	310	112D18L0310	3336600196438	1
20	250	310	112D20L0310	3336600196445	1
L 400 x 460					
8	400	460	112D08L0460	3336600201385	1
10	400	460	112D10L0460	3336600196315	1
12	400	460	112D12L0460	3336600196360	1
14	400	460	112D14L0460	3336600196391	1
16	400	460	112D16L0460	3336600196421	1
18	400	460	112D18L0460	3336600201446	1
20	400	460	112D20L0460	3336600196452	1
22	400	460	112D22L0460	3336600201460	1
24	400	460	112D24L0460	3336600201484	1
25	400	460	112D25L0460	3336600201507	1
26*	400	460	112D26L0460	3336600201521	1
28*	400	460	112D28L0460	3336600201538	1
30*	400	460	112D30L0460	3336600201545	1
32*	400	460	112D32L0460	3336600201552	1

* 6 cutting edges + carved helix



Grey plastic clip

ALL SETS PAGES 114-115



112Q

DIAGER, MANUFACTURER

Diager: A family business since 1953, a French industrialist with recognized know-how, and a know-how that we cultivate daily. It is also a state of mind, of deep values that guide our actions.

Diager: A "Made In Jura" company that is expanding its reach well beyond French borders with a mexican, Diamex, and a German, USH, implantation. It is a real desire to be alongside our customers, to support them. Always with this "Diager spirit" which testifies to our daily involvement.



Ref. 110

Twister Plus



Hammer drill bit 2 cutting edges compatible SDS-plus

Special carbide tip profile combined with TRI-ZONES helix reduce drilling time, limits wear and increases drill bit life time.

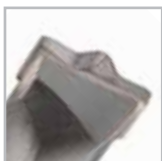

Concrete, Stone, Brick, Breeze block



FAST DRILLING

Features

- Concrete breaker tip.
- «Z» line centering tip.
- Variable helix tri-zones.

Benefits

- Accuracy in starting the hole.
- Perfectly round and calibrated hole.
- Fast dust evacuation.
- Resistance and long life.

Shank Hammer drill



Compatible SDS-plus

Ø	WL	TL	Ref.	Gencod	Qty
L 50 x 110					
4	50	110	110D04L0110	3336600008359	1
5	50	110	110D05L0110	3336600008366	1
5.5	50	110	110D05.5L0110	3336600023253	1
6	50	110	110D06L0110	3336600008373	1
6.5	50	110	110D06.5L0110	3336600023260	1
7	50	110	110D07L0110	3336600008380	1
8	50	110	110D08L0110	3336600008397	1
10	50	110	110D10L0110	3336600008403	1
L 100 x 160					
4	100	160	110D04L0160	3336600067837	1
5	100	160	110D05L0160	3336600008410	1
5.5	100	160	110D05.5L0160	3336600023277	1
6	100	160	110D06L0160	3336600008427	1
6.5	100	160	110D06.5L0160	3336600020849	1
7	100	160	110D07L0160	3336600008434	1
8	100	160	110D08L0160	3336600008441	1
9	100	160	110D09L0160	3336600008458	1
10	100	160	110D10L0160	3336600008465	1
11	100	160	110D11L0160	3336600008472	1
12	100	160	110D12L0160	3336600008489	1
13	100	160	110D13L0160	3336600008496	1
14	100	160	110D14L0160	3336600008502	1
15	100	160	110D15L0160	3336600008519	1
16	100	160	110D16L0160	3336600008526	1

Ø	WL	TL	Ref.	Gencod	Qty
L 150 x 210					
5	150	210	110D05L0210	3336600076457	1
6	150	210	110D06L0210	3336600008533	1
6.5	150	210	110D06.5L0210	3336600020856	1
7	150	210	110D07L0210	3336600020863	1
8	150	210	110D08L0210	3336600008540	1
9	150	210	110D09L0210	3336600008557	1
10	150	210	110D10L0210	3336600008564	1
11	150	210	110D11L0210	3336600030107	1
12	150	210	110D12L0210	3336600008571	1
13	150	210	110D13L0210	3336600008588	1
14	150	210	110D14L0210	3336600008595	1
15	150	210	110D15L0210	3336600008601	1
16	150	210	110D16L0210	3336600008618	1
18	150	210	110D18L0210	3336600008625	1
20	150	210	110D20L0210	3336600008632	1
22	150	210	110D22L0210	3336600008649	1
24	150	210	110D24L0210	3336600014817	1
25	150	210	110D25L0210	3336600008656	1
L 200 x 260					
5.5	200	260	110D05.5L0260	3336600185647	1
6	200	260	110D06L0260	3336600008663	1
6.5	200	260	110D06.5L0260	3336600076389	1
7	200	260	110D07L0260	3336600021556	1
8	200	260	110D08L0260	3336600008670	1
10	200	260	110D10L0260	3336600008687	1
12	200	260	110D12L0260	3336600008694	1
13	200	260	110D13L0260	3336600008700	1
14	200	260	110D14L0260	3336600008717	1
15	200	260	110D15L0260	3336600008724	1
16	200	260	110D16L0260	3336600008731	1
18	200	260	110D18L0260	3336600008748	1
20	200	260	110D20L0260	3336600008755	1
22	200	260	110D22L0260	3336600008762	1
24	200	260	110D24L0260	3336600014824	1
25	200	260	110D25L0260	3336600008779	1



Ø	WL	TL	Ref.	Gencod	Qty
L 250 x 310					
5	250	310	110D05L0310	3336600166189	1
5.5	250	310	110D05.5L0310	3336600185654	1
6	250	310	110D06L0310	3336600023291	1
8	250	310	110D08L0310	3336600023307	1
10	250	310	110D10L0310	3336600023314	1
12	250	310	110D12L0310	3336600023321	1
13	250	310	110D13L0310	3336600054950	1
14	250	310	110D14L0310	3336600023338	1
15	250	310	110D15L0310	3336600023345	1
16	250	310	110D16L0310	3336600023352	1
18	250	310	110D18L0310	3336600023369	1
20	250	310	110D20L0310	3336600023376	1
22	250	310	110D22L0310	3336600023383	1
24	250	310	110D24L0310	3336600023390	1
25	250	310	110D25L0310	3336600023406	1
26	250	310	110D26L0310	3336600164796	1
28	250	310	110D28L0310	3336600164826	1
L 350 x 410					
8	350	410	110D08L0410	3336600008786	1
10	350	410	110D10L0410	3336600008793	1
12	350	410	110D12L0410	3336600008809	1
13	350	410	110D13L0410	3336600008816	1
14	350	410	110D14L0410	3336600008823	1
16	350	410	110D16L0410	3336600008847	1
18	350	410	110D18L0410	3336600008854	1
20	350	410	110D20L0410	3336600008878	1
22	350	410	110D22L0410	3336600008885	1
24	350	410	110D24L0410	3336600014831	1
25	350	410	110D25L0410	3336600008892	1



Grey plastic clip

Ø	WL	TL	Ref.	Gencod	Qty
L 400 x 460					
6	400	460	110D06L0460	3336600119369	1
8	400	460	110D08L0460	3336600023413	1
10	400	460	110D10L0460	3336600023420	1
12	400	460	110D12L0460	3336600023437	1
14	400	460	110D14L0460	3336600023451	1
16	400	460	110D16L0460	3336600023475	1
18	400	460	110D18L0460	3336600023482	1
20	400	460	110D20L0460	3336600023505	1
22	400	460	110D22L0460	3336600023512	1
24	400	460	110D24L0460	3336600023529	1
25	400	460	110D25L0460	3336600023536	1
26	400	460	110D26L0460	3336600164802	1
28	400	460	110D28L0460	3336600164833	1
30	400	460	110D30L0460	3336600164857	1
L 550 x 610					
8	550	610	110D08L0610	3336600008908	1
10	550	610	110D10L0610	3336600008915	1
12	550	610	110D12L0610	3336600008922	1
14	550	610	110D14L0610	3336600008946	1
16	550	610	110D16L0610	3336600008953	1
18	550	610	110D18L0610	3336600008960	1
20	550	610	110D20L0610	3336600008977	1
22	550	610	110D22L0610	3336600008984	1
24	550	610	110D24L0610	3336600027367	1
25	550	610	110D25L0610	3336600008991	1
26	550	610	110D26L0610	3336600164819	1
L 940 x 1000					
8	940	1000	110D08L1000	3336600009004	1
10	940	1000	110D10L1000	3336600009011	1
12	940	1000	110D12L1000	3336600009028	1
14	940	1000	110D14L1000	3336600009035	1
16	940	1000	110D16L1000	3336600009042	1
18	940	1000	110D18L1000	3336600009059	1
20	940	1000	110D20L1000	3336600009066	1
22	940	1000	110D22L1000	3336600009073	1
25	940	1000	110D25L1000	3336600009080	1

Ref. 108L Hammer drill bit 2 cutting edges compatible SDS-plus pack 12 pcs

Ø	WL	TL	Ref.	Gencod	Qty
L 50 x 110					
5	50	110	108LD05L0110	3336600152113	1
6	50	110	108LD06L0110	3336600186873	1
8	50	110	108LD08L0110	3336600152168	1
L 100 x 160					
5	100	160	108LD05L0160	3336600152120	1
6	100	160	108LD06L0160	3336600152137	1
7	100	160	108LD07L0160	3336600152151	1
8	100	160	108LD08L0160	3336600152175	1
10	100	160	108LD10L0160	3336600152205	1
12	100	160	108LD12L0160	3336600152229	1
14	100	160	108LD14L0160	3336600152250	1
L 150 x 210					
6	150	210	108LD06L0210	3336600152144	1
8	150	210	108LD08L0210	3336600152182	1
10	150	210	108LD10L0210	3336600152212	1
12	150	210	108LD12L0210	3336600152236	1
16	150	210	108LD16L0210	3336600152267	1
L 200 x 260					
6	200	260	108LD06L0260	3336600157484	1
8	200	260	108LD08L0260	3336600157491	1
10	200	260	108LD10L0260	3336600157507	1
12	200	260	108LD12L0260	3336600157514	1
14	200	260	108LD14L0260	3336600157521	1
L 250 x 310					
8	250	310	108LD08L0310	3336600152199	1
12	250	310	108LD12L0310	3336600152243	1
16	250	310	108LD16L0310	3336600152274	1



Quadrapack incolore



Ref. 108R Hammer drill bit 2 cutting edges compatible SDS-plus pack 50 pcs



Ø	WL	TL	Ref.	Gencod	Qty
L 50 x 110					
5	50	110	108RD05L0110	3336600152281	1
6	50	110	108RD06L0110	3336600152298	1
8	50	110	108RD08L0110	3336600182998	1
L 100 x 160					
6	100	160	108RD06L0160	3336600152304	1
8	100	160	108RD08L0160	3336600152311	1
10	100	160	108RD10L0160	3336600152328	1
L 200 x 260					
8	200	260	108RD08L0260	3336600168282	1



ALL SETS
PAGES 114-115



102C



100C



136C



105D



116D

New TRI-ZONE Flute

③

Extraction area, the patented shape associate a compression area with a decompression chamber to extract thin dust to hole exit

②

Dust extraction accelerating area to the rear.

①

Very fast dust evacuation area, adapted to high dust volume.

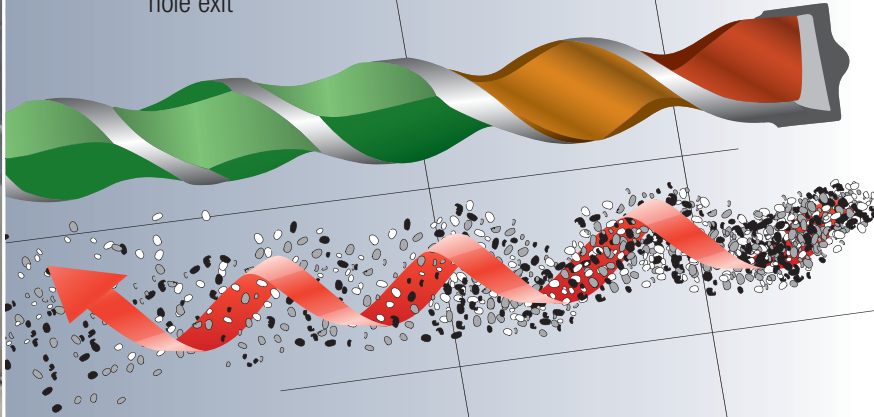

EXTRACTION

ACCELERATION

EVACUATION

New Carbide Tip

3 CONTACT POINTS

Focus the percussion efforts to the drilling axis. Increase the speed, the destruction power and the accuracy.

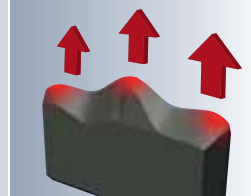

Z FORM SHARP TIP

Chiseling effect and aggressivity increased. High accuracy on the hole starting.



CERTIFICATES, LABELS & AWARDS



ISO 9001/ISO 14001

The ISO 9001 label promotes a quality management system. The ISO 14001 label promotes an environmental management system.



RSE

The aim of a company's CSR strategy is to consider its overall performance under the three economic, corporate and environmental pillars.



PGM

Certification for hammer drill bits and cylindrical shanks since 1978. It monitors standards and inspects products and observes manufacturers' quality.



MADE IN JURA

Founding member of Made In Jura under registration number 160002. Made in Jura is a vehicle for our responsibility.



CERTIFICATION OFG

OFG certification for our hammer drill bit, cylindrical drill bit and diamond tool ranges. This label is obtained after an on-site audit by a certifying body and is the only one that guarantees the French manufacture of a product. It guarantees that 50% to 100% of the product's unit cost price is French and that the product assumes its essential features in France. It promotes French industry, jobs created in France and regional roots.



OEA-FULL

Authorised Economic Operator Full status Certification - Customs simplifications/ Safety and security



COQ VERT

The Coq Vert Community is a community of leaders who are committed to ecological and energy transition.



ARS

The overall objective of the PNNS (France's National Health and Nutrition Programme) is to improve the state of health of the whole population by working on nutrition.



PEFC

The Programme for the Endorsement of Forest Certification is a private forest supply chain certification system which promotes sustainable forest management.



FRENCH FAB

French Fab is a French label that aims to unite manufacturers and boost the promotion of French industry abroad.



BPI EXCELLENCE

BPI France Excellence is the business network for growing companies. The aim of this network is to enable companies to connect.



EISEN AWARD IN COLOGNE

Commitment to Sustainable Development



NETWORK TROPHY CSR BFC

Rewards our commitment to the ecological and energy transition



GRAND PRIX DES ETI

BFM Business Banque Palatine



MADE IN JURA AWARD FOR THE CHALLENGES OF TOMORROW

Recognition of our CSR commitment and our regional roots



BRICKSTER DRILL BIT INNOVATION AWARD

Unis pour Bâtir Magazine Implementation Performance Category



CSR NETWORK AWARD BOURGOGNE FRANCHE-COMTÉ

Award for CSR good practices, in particular with regard to regional roots

Ref.
104

Wallster



Hollow block hammer drill bit 2 cutting edges compatible SDS-plus

Specially designed to drill through hollow bricks and hollow blocks without damaging wall. Allows to make quality holes that make the anchors more reliable.



• NOT DAMAGED WALL = OPTIMIZED ANCHORING

Features

- Semi positive tip.
- Tip angle 130°.
- Micro percussion system.
- Long pitch.
- Impact reducer.

Benefits

- Hollow block wall is not damaged.
- Perfectly round and calibrated hole.
- Increases the strength of the anchors.
- Drill bit stay in the drilling axis.
- Drilling through insulations.

Applications

- Anchoring in hollow block.



Breeze block, Hollow brick

Shank Hammer drill

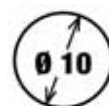

Compatible SDS-plus

Ø	WL	TL	Ref.	Gencod	Qty
L 100 x 160					
5	100	160	104D05L0160	3336600187214	1
6	100	160	104D06L0160	3336600187221	1
8	100	160	104D08L0160	3336600187238	1
10	100	160	104D10L0160	3336600187245	1
L 200 x 260					
6	200	260	104D06L0260	3336600182240	1
8	200	260	104D08L0260	3336600182103	1
10	200	260	104D10L0260	3336600182110	1
12	200	260	104D12L0260	3336600182127	1
14	200	260	104D14L0260	3336600182134	1
16	200	260	104D16L0260	3336600182141	1
L 400 x 460					
8	400	460	104D08L0460	3336600182158	1
10	400	460	104D10L0460	3336600182165	1



PLV picking-counter 30 drills to choose Delevry unmounted Ref.C00084

VIDEO DEMO



**UP TO 3
TIMES
STRONGER
RESISTANCE**

COMPARATIVE TESTS: DRILLING AND ANCHORING IN A HOLLOW BLOCK

STANDARD drill bit



Drilling
The wall is damaged, only 7 mm thickness remains.



Test of tearing for a chemical fixing
The fixation quickly gives in. Break in 250 kg.

Hammer drill WALLSTER



Drilling
The wall is intact, and keeps its original thickness of 16 mm.

Test of tearing for a chemical fixing
The fixation resists perfectly. It is the wall which gives in. Break in 700 kg.

EFFICIENT IN ALL HOLLOW BLOCKS OF THE MARKET

Slap, breeze block, breeze block Easytherm®, Rubbe, hollow brick, brick for bonding, brick pole, brick rabbet Wienerberger®, plank, brick of arase...



Diager developed specially a bit to drill hollow blocks without degrading walls. This special dill bit for hollow blocks allows to realize qualitative holes which enhance reliability of the anchorings.

Ref.
184

Granit

Granit hammer drill bit 2 cutting edges compatible SDS-plus

Drill specially designed for drilling granit rock (class 1 to 3) and ceramics.



• DRILLING INTO GRANIT CLASS 1 TO 3

Features

- Special carbide tip for granit rock.
- Tip angle 130°.

Benefits

- To drill into granit rock up to class 3.

Applications

- Installation of granite worktop.



Granit, Concrete, Stone, Ceramic tile, Brick

Shank Hammer drill

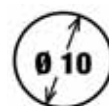

Compatible SDS-plus

Ø	WL	TL	Ref.	Gencod	Qty
L 25 x 85					
3	25	85	184D03L0085	3336600023802	1
L 50 x 110					
4	50	110	184D04L0110	3336600023819	1
5	50	110	184D05L0110	3336600022119	1
6	50	110	184D06L0110	3336600022126	1
8	50	110	184D08L0110	3336600022133	1
10	50	110	184D10L0110	3336600023826	1
L 100 x 160					
4	100	160	184D04L0160	3336600023833	1
5	100	160	184D05L0160	3336600023840	1
6	100	160	184D06L0160	3336600022140	1
7	100	160	184D07L0160	3336600054714	1
8	100	160	184D08L0160	3336600022157	1
10	100	160	184D10L0160	3336600022164	1
12	100	160	184D12L0160	3336600023857	1
14	100	160	184D14L0160	3336600183407	1
16	100	160	184D16L0160	3336600183414	1



Black plastic clip

100% SDS-PLUS

Features	Ref.	Gencod
POS-COUNTER SDS-PLUS (48PCS)	C00115	3336600201804
IOP SHELF TALKER BOOSTER-plus	B00447	3336609008619
IOP SHELF TALKER 4G4	B00510	3336609008800
IOP SHELF TALKER TWISTER-PLUS	B00519	3336609010452
TWIN STICK	M00075	3336600196964
BIN WITH REMOVAL DIVIDER (Width 500mm x Depth 500 mm)	M00197	3336609008089
MONOBLOC DISPLAY	M00171	3336609006844
PR 24 DISPLAY - STRUCTURE ONLY (delivered flat)	M00135	3336609007643
6 HOOKS RACK (with label holder)	M00101	3336609008640
LOAD BAR FOR PR24 STRUCTURE	M00102	3336609007650
PIN FOR LOAD BAR M00102	M00103	3336609007339
COMMUNICATIONS KIT FOR PR24	M00107	3336609008657

POS-Counter

To promote SDS-plus drill bits, packaged on plastic clip.
Contains 48 locations:
6 facing, 8 deep.
Delivered to be shaped.
Ref. C00115



Storage bin

For storing SDS-plus drill bits delivered in quadpack or twistpack.
Removal dividers delivered with the display. Arranged on shelf, bottom of sales shelf. Magnetic bottom for optimal stability.
Ref. M00197

DISPLAY PRONG

To be arranged on a counter or hung on perforated metal sheet.



Monobloc version

18 simple hooks. No label holders.
Ref. M00170



Disassembled version

Can contain up to 4 racks of 6 double hooks.
Double label holder on each rack. Ref. M00135

NEW SDS-MAX DRILL BIT

ULTIMAX 646

100% CARBIDE HEAD - 10 CUTTERS

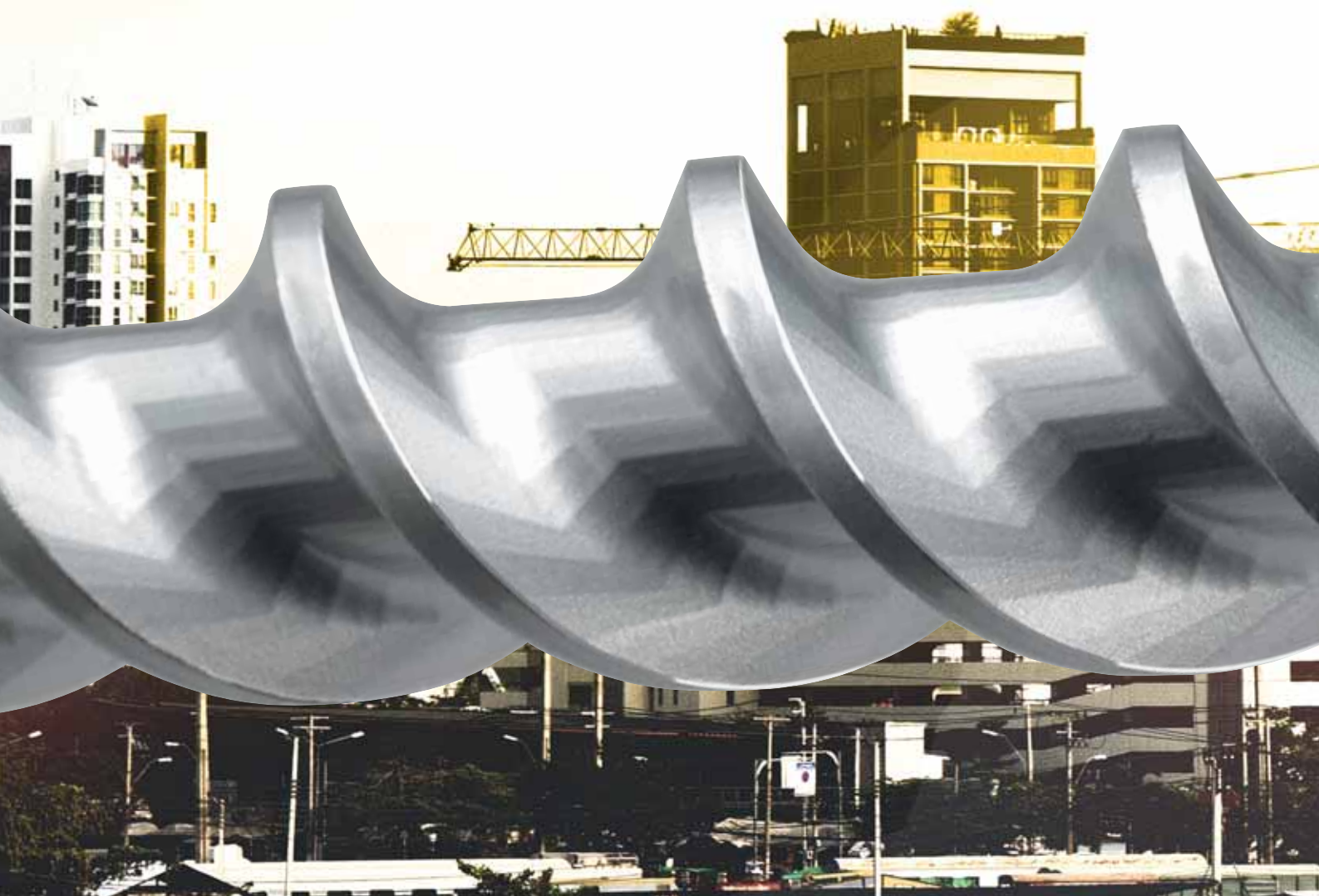

**DRILLS THROUGH
OVERSIZED REBAR***

+ 1000 HOLES



* Hand tests with 20 joules hammer drill

* Tests on an automatic bench, 8,8 joules hammer drill, C50/60 concrete, 150 mm hole depth, 24 mm hole diameter

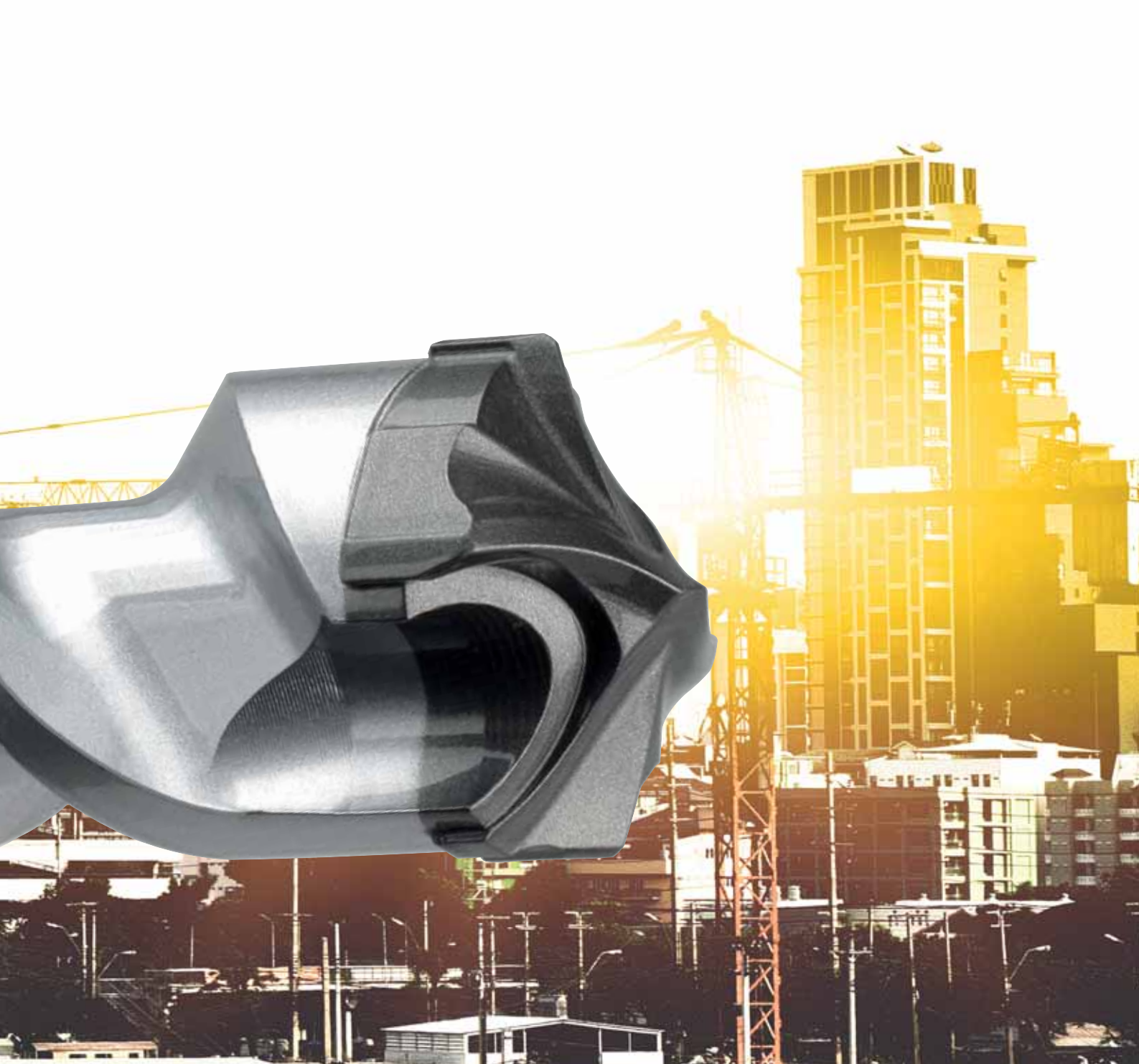
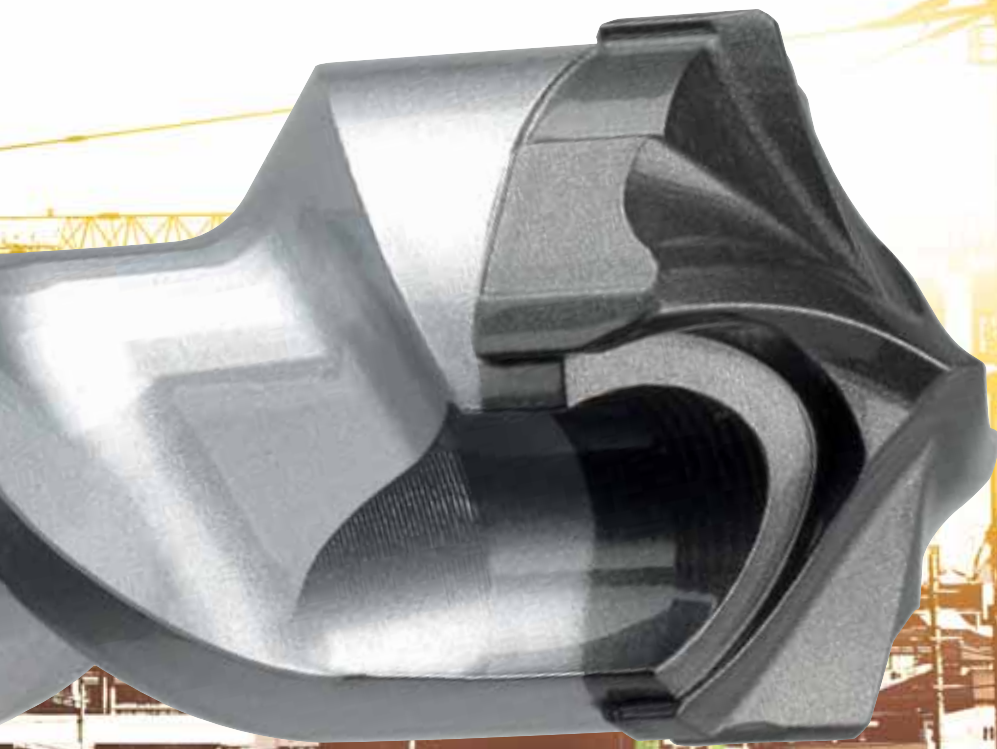

HIGH SPEED DRILLING*

**IDEAL FOR POWERFUL
HAMMER DRILL**

**30 CM
PER MINUTE**



**20
JOULES
>12 KG**

* Tests on an automatic bench, C50/60 concrete

Ref.
166

Ultimax 646 **ULTIMAX 646**

Hammer drill bit 10 cutters compatible
SDS-max

SDS-max drill bit with massive carbide head technology. High performance for drilling hard concrete and reinforced concrete.



Reinforced concrete, Concrete

+

• 10 CUTTING EDGES TECHNOLOGY

Features

- Massive carbide head.
- 10 cutters geometry.
- 6 lateral stabiliser.
- Elliptical 130° angle tip.
- Centering point.

Benefits

- Fast drilling speed.
- High destruction power.
- Heat resistance.
- Low vibration.
- Longer lifespan.

Applications

- Fixing steel rebar.
- Passage of pipes or electrical cable.

Shank Hammer drill



Compatible
SDS-max

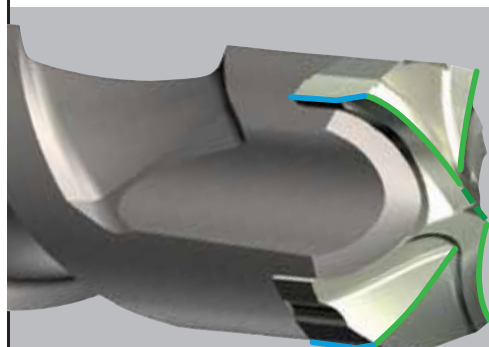

6 FRONT CUTTERS 2 main ones
2 secondary ones
2 central ones

Heavy rebar cutting power and stronger chiseling effect thanks to optimal combination of concave and convex cutters. Elliptic 130° angle for better penetration. Aggressive center point.



4 SIDE CUTTERS

*Wear mark
Guarantees concentricity and accurate dimensions.*

6 SIDE STABILISERS

Hammering efforts focus on the drilling axis. Optimum performance even with most powerful hammerdrills. Vibration control.

VIDEO DEMO



Ø	WL	TL	Ref.	Gencod	Qty	Ø	WL	TL	Ref.	Gencod	Qty
L 200 x 340						L 550 x 690					
12*	200	340	166D12L0340	3336600004818	1	16	550	690	166D16L0690	3336600005327	1
14	200	340	166D14L0340	3336600004825	1	18	550	690	166D18L0690	3336600005334	1
15*	200	340	166D15L0340	3336600004832	1	20	550	690	166D20L0690	3336600005358	1
16*	200	340	166D16L0340	3336600004849	1	22	550	690	166D22L0690	3336600005365	1
18	200	340	166D18L0340	3336600004856	1	24	550	690	166D24L0690	3336600005372	1
20	200	340	166D20L0340	3336600004870	1	25	550	690	166D25L0690	3336600005389	1
22	200	340	166D22L0340	3336600004887	1	26	550	690	166D26L0690	3336600005396	1
24	200	340	166D24L0340	3336600004894	1	28	550	690	166D28L0690	3336600005402	1
25	200	340	166D25L0340	3336600004900	1	30	550	690	166D30L0690	3336600005426	1
26	200	340	166D26L0340	3336600004917	1	32	550	690	166D32L0690	3336600005433	1
28	200	340	166D28L0340	33366000068261	1	35	550	690	166D35L0690	3336600005440	1
30	200	340	166D30L0340	33366000028760	1	36	550	690	166D36L0690	3336600005457	1
32	200	340	166D32L0340	33366000068278	1	38	550	690	166D38L0690	33366000028685	1
35	200	340	166D35L0340	33366000054707	1	40**	550	690	166D40L0690	33366000028692	1
36	200	340	166D36L0340	33366000063440	1	42**	550	690	166D42L0690	33366000063389	1
38	200	340	166D38L0340	33366000063457	1	45**	550	690	166D45L0690	33366000063396	1
40**	200	340	166D40L0340	33366000063464	1	52**	550	690	166D52L0690	3336600201330	1
42**	200	340	166D42L0340	33366000063402	1	L 780 x 920					
45**	200	340	166D45L0340	33366000063471	1	16	780	920	166D16L0920	3336600005464	1
L 400 x 540						18	780	920	166D18L0920	3336600005471	1
12*	400	540	166D12L0540	3336600004924	1	20	780	920	166D20L0920	3336600005495	1
14	400	540	166D14L0540	3336600004931	1	22	780	920	166D22L0920	3336600005501	1
15*	400	540	166D15L0540	3336600004948	1	24	780	920	166D24L0920	3336600005518	1
16	400	540	166D16L0540	3336600004955	1	25	780	920	166D25L0920	3336600005525	1
18	400	540	166D18L0540	3336600005136	1	26	780	920	166D26L0920	3336600005532	1
20	400	540	166D20L0540	3336600005150	1	28	780	920	166D28L0920	3336600005549	1
22	400	540	166D22L0540	3336600005167	1	30	780	920	166D30L0920	3336600005563	1
24	400	540	166D24L0540	3336600005174	1	32	780	920	166D32L0920	3336600005570	1
25	400	540	166D25L0540	3336600005181	1	35	780	920	166D35L0920	3336600005587	1
26	400	540	166D26L0540	3336600005198	1	36	780	920	166D36L0920	3336600005594	1
28	400	540	166D28L0540	3336600005204	1	40**	780	920	166D40L0920	3336600005600	1
30	400	540	166D30L0540	3336600005228	1	42**	780	920	166D42L0920	33366000021464	1
32	400	540	166D32L0540	3336600005235	1	45**	780	920	166D45L0920	33366000024113	1
35	400	540	166D35L0540	3336600005242	1	L 1160 x 1300					
36	400	540	166D36L0540	3336600005259	1	20	1160	1300	166D20L1300	33366000063297	1
38	400	540	166D38L0540	33366000023093	1	22	1160	1300	166D22L1300	33366000063303	1
40**	400	540	166D40L0540	33366000023109	1	25	1160	1300	166D25L1300	33366000068193	1
42**	400	540	166D42L0540	33366000023116	1	28	1160	1300	166D28L1300	33366000063310	1
45**	400	540	166D45L0540	33366000063419	1	32	1160	1300	166D32L1300	33366000028746	1
52**	400	540	166D52L0540	3336600201323	1	35	1160	1300	166D35L1300	33366000063327	1
						36	1160	1300	166D36L1300	33366000063334	1
						42**	1160	1300	166D42L1300	33366000063341	1
						45**	1160	1300	166D45L1300	33366000063358	1
						L 1360 x 1500					
						20	1360	1500	166D20L1500	33366000024120	1
						24	1360	1500	166D24L1500	33366000024137	1
						25	1360	1500	166D25L1500	33366000037625	1
						28	1360	1500	166D28L1500	33366000024144	1
						32	1360	1500	166D32L1500	33366000024151	1
						36	1360	1500	166D36L1500	33366000024168	1
						40**	1360	1500	166D40L1500	33366000063365	1
						42**	1360	1500	166D42L1500	33366000063372	1
						45**	1360	1500	166D45L1500	33366000027091	1

* 3 cutting edges
** 6 cutting edges



Floor display
Ultimax/Chisels

Ref.	Gencod
M00208	3336609010964



Black plastic clip

Power recommendation machine / drill diameter.
Using a machine not adapted to the diameter can break the drill bit.

MACHINE Attachment	Joule strike force	Weight in kg	DIAMETER																			
			12	14	16	18	20	22	24	26	28	30	32	34	36	38	40	42	44	46	48	50
SDS-max wired perforator	8-9	6-7																				
	12-13	8-9																				
	19-20	11-12																				

Optimal use Occasional use Not compatible



Ref.
168

Ultimax



Hammer drill bit 6 cutters compatible SDS-max

SDS-max drill bit with massive carbide head technology. High performance for drilling hard concrete and reinforced concrete.



Reinforced concrete, Concrete

+

• 6 CUTTING EDGES TECHNOLOGY

Features

- 3 self-centering concrete breaker plates.
- Carbide insert with 6 cutting edges.
- Progressive core propeller.
- SDS-max compatible attachment.

Benefits

- Unequaled drilling speed.
- High destruction power and robustness.
- Heat resistance.
- Comfort of use, low vibrations.
- Extreme lifespan.

Applications

- Fixing steel rebar.
- Passage of pipes or electrical cable.

Shank

Hammer Drill



Compatible
SDS-max



> 5 KG

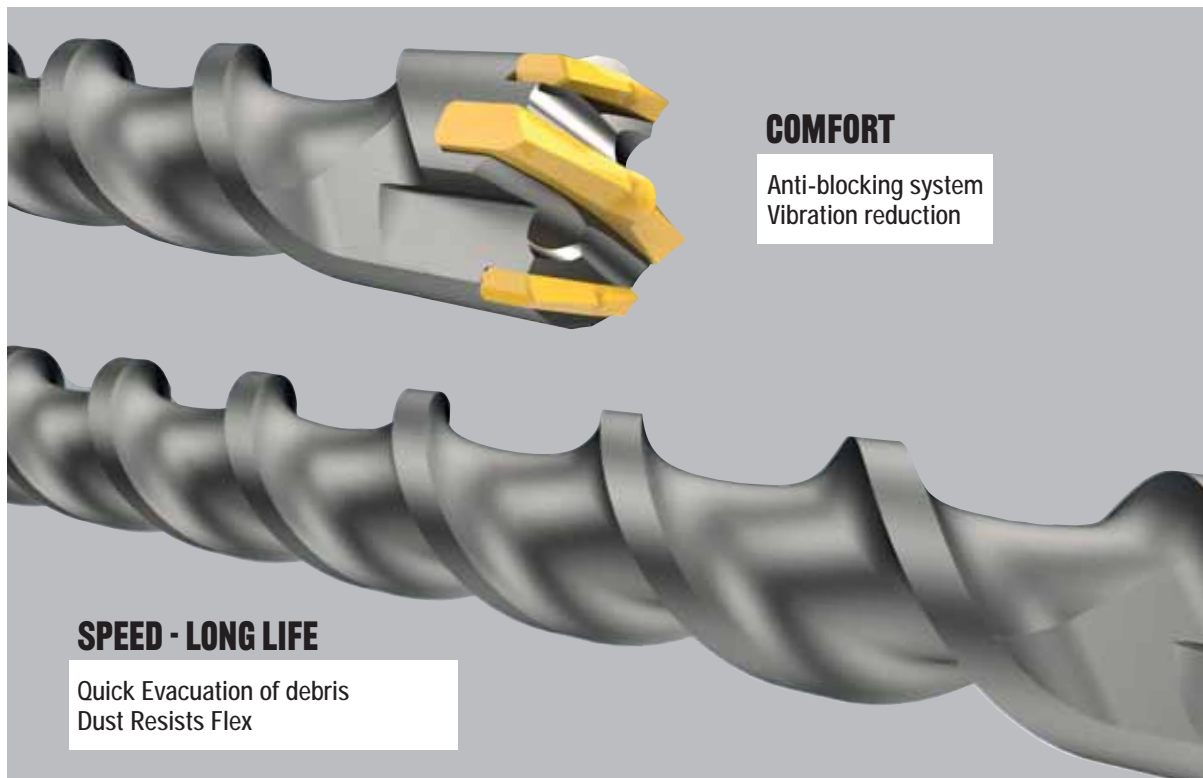

COMFORT

Anti-blocking system
Vibration reduction

SPEED - LONG LIFE

Quick Evacuation of debris
Dust Resists Flex

VIDEO DEMO





Ø	WL	TL	Ref.	Gencod	Qty	Ø	WL	TL	Ref.	Gencod	Qty
L 200 x 340						25	550	690	168D25L0690	3336600192850	1
*12	200	340	168D12L0340	3336600193130	1	26	550	690	168D26L0690	3336600193406	1
*14	200	340	168D14L0340	3336600193147	1	28	550	690	168D28L0690	3336600193437	1
15	200	340	168D15L0340	3336600193161	1	30	550	690	168D30L0690	3336600193499	1
16	200	340	168D16L0340	3336600192775	1	32	550	690	168D32L0690	3336600192553	1
18	200	340	168D18L0340	3336600192799	1	35	550	690	168D35L0690	3336600193567	1
20	200	340	168D20L0340	3336600193239	1	36	550	690	168D36L0690	3336600192928	1
22	200	340	168D22L0340	3336600193277	1	38	550	690	168D38L0690	3336600193635	1
24	200	340	168D24L0340	3336600193314	1	40	550	690	168D40L0690	3336600193642	1
25	200	340	168D25L0340	3336600193369	1	42	550	690	168D42L0690	3336600192966	1
26	200	340	168D26L0340	3336600193383	1	45	550	690	168D45L0690	3336600192980	1
28	200	340	168D28L0340	3336600193420	1	52	550	540	168D52L0690	3336600202863	1
30	200	340	168D30L0340	3336600193475	1	L 780 x 920					
32	200	340	168D32L0340	3336600193512	1	16	780	920	168D16L0920	3336600192461	1
35	200	340	168D35L0340	3336600193543	1	18	780	920	168D18L0920	3336600193208	1
45	200	340	168D45L0340	3336600193710	1	20	780	920	168D20L0920	3336600193246	1
L 400 x 540						22	780	920	168D22L0920	3336600193291	1
*12	400	540	168D12L0540	3336600192454	1	24	780	920	168D24L0920	3336600193345	1
*14	400	540	168D14L0540	3336600193154	1	25	780	920	168D25L0920	3336600192508	1
16	400	540	168D16L0540	3336600192782	1	28	780	920	168D28L0920	3336600193444	1
18	400	540	168D18L0540	3336600192805	1	30	780	920	168D30L0920	3336600193505	1
20	400	540	168D20L0540	3336600192812	1	32	780	920	168D32L0920	3336600192560	1
22	400	540	168D22L0540	3336600192836	1	35	780	920	168D35L0920	3336600193574	1
24	400	540	168D24L0540	3336600193321	1	36	780	920	168D36L0920	3336600193604	1
25	400	540	168D25L0540	3336600192843	1	40	780	920	168D40L0920	3336600193659	1
26	400	540	168D26L0540	3336600193390	1	42	780	920	168D42L0920	3336600193680	1
28	400	540	168D28L0540	3336600192874	1	45	780	920	168D45L0920	3336600193994	1
30	400	540	168D30L0540	3336600193482	1	L 1160 x 1300					
32	400	540	168D32L0540	3336600192546	1	20	1160	1300	168D20L1300	3336600193253	1
35	400	540	168D35L0540	3336600193550	1	22	1160	1300	168D22L1300	3336600193307	1
36	400	540	168D36L0540	3336600192911	1	28	1160	1300	168D28L1300	3336600193451	1
38	400	540	168D38L0540	3336600192935	1	32	1160	1300	168D32L1300	3336600193529	1
40	400	540	168D40L0540	3336600192942	1	35	1160	1300	168D35L1300	3336600193581	1
42	400	540	168D42L0540	3336600192959	1	L 1360 x 1500					
45	400	540	168D45L0540	3336600192973	1	20	1360	1500	168D20L1500	3336600193260	1
52	400	540	168D52L0540	3336600202856	1	22	1360	1500	168D22L1500	3336600202481	1
L 550 x 690						25	1360	1500	168D25L1500	3336600192515	1
16	550	690	168D16L0690	3336600193178	1	28	1360	1500	168D28L1500	3336600193468	1
18	550	690	168D18L0690	3336600193192	1	32	1360	1500	168D32L1500	3336600193536	1
20	550	690	168D20L0690	3336600192829	1	40	1360	1500	168D40L1500	3336600193666	1
22	550	690	168D22L0690	3336600193284	1	45	1360	1500	168D45L1500	3336600193734	1
24	550	690	168D24L0690	3336600193338	1	* 2 cutting edges					



Ref.
168

Ultimax long lengths

Hammer drill bit 6 cutters compatible
SDS-max up to 4 meters

SDS Max drill bit with 6 high performance cutting edges, for drilling hard concrete and reinforced concrete. Requires additional time for product availability.

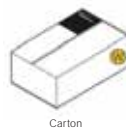

Ø	WL	TL	Ref.	Gencod	Qty
L 1580 x 1925					
22	1860	1925	168D22L1925	3336600202498	1
25	1860	1925	168D25L1925	3336600192522	1
L 2080 x 2500					
22	2360	2500	168D22L2500	3336600192478	1
25	2360	2500	168D25L2500	3336600202511	1
L 2580 x 3000					
22	2860	3000	168D22L3000	3336600202504	1
25	2860	3000	168D25L3000	3336600202528	1
L 3080 x 3500					
22	3360	3500	168D22L3500	3336600192485	1
25	3360	3500	168D25L3500	3336600202535	1
L 3580 x 3850					
22	3710	3850	168D22L3850	3336600192492	1
25	3710	3850	168D25L3850	3336600202542	1

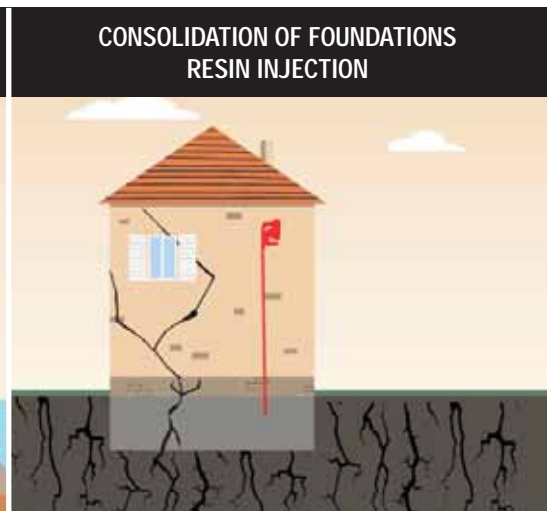
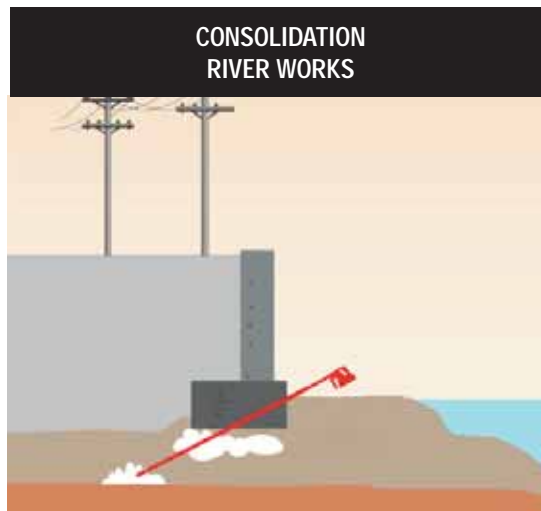

DUST-FREE DRILL BIT

SPEEDUSTER 646

TARGET: DUST-FREE

SPEEDUSTER dust-free drill bit with the massive head system allows immediate dust extraction.

SPEEDUSTER drills faster and without any blocking, its lifetime is significantly longer.



CLEANER WORKSITE



SPEEDUSTER drills and extracts dust in one step. Job is done faster. Indoor equipment is safe from dust and lasts longer.

PROTECTION



In compliance with the new international dust exposure regulations, workers are now protected from dust. According to countries, the law establishes the value of exposure to quartz silica (breathable dust) at 0,1 mg / m³ for 8 working hours.

FAST SPEED DRILLING

DRILLS TWICE FASTER

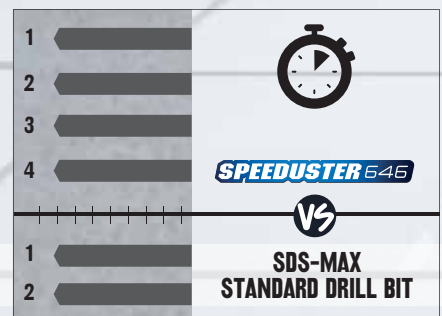

SPEEDUSTER drills 4 holes vs 2 compared to a standard SDS-Max drill bit.



DRILLING COMPARISON

**SDS-MAX STANDARD
DRILL BIT**



SPEEDUSTER 646



1 KG OF DUST



DUST-FREE



Drilling diameter 1-1/4", length 40" depth in C50/60 concrete

EFFICIENCY

FASTENING IN 2 STEPS ONLY

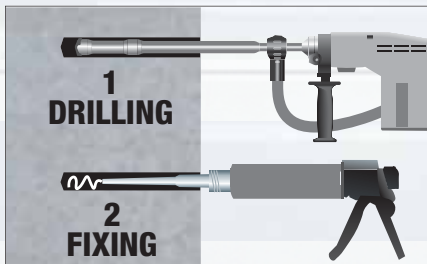

Holes drilling and cleaning are made in a single stage. Chemical fastening resistance is multiplied tenfold thanks to perfectly clean holes. There are a real time-saving and a better profitability of worksites.

Ref.
114

Speeduster **SPEEDUSTER**

Suction drill bit compatible SDS-plus

Speeduster SDS-plus drill bit enables immediate and total dust removal. The suction system allows faster drilling time.



Reinforced concrete, Concrete, Granit, Stone, Brick

+

• 2 IN 1 : DRILLING AND VACUUM

Features

- Monobloc carbide tip 3 cutting edges.
- 3 suction holes.
- Connective sleeve.
- Centering point.

Benefits

- Working without dust.
- Drilling and cleaning hole in one operation.
- Drilling concrete with rebar.
- Long life.

Applications

- Fixing steel rebar.
- Clean rooms, hospitals, laboratories...

Shank Hammer drill

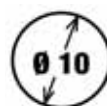

Compatible SDS-plus



Black plastic clip

Ø	WL	TL	Ref.	Gencod	Qty
3 cutting edges					
12	265	410	114D12L0410	3336600194175	1
14	265	410	114D14L0410	3336600194182	1
16	265	410	114D16L0410	3336600194199	1
18	265	410	114D18L0410	3336600194205	1
20	265	410	114D20L0410	3336600194212	1



VIDEO DEMO



Ref.
114DPLUS

Sleeve spare part

Connecting sleeve for SDS-plus speedster drill bit.



Twistpack

Ref.	Gencod	Qty
SDS-PWLS 114DPWLS	3336600194229	1



Ref.
161

Speeduster 646 **SPEEDUSTER 646**

Suction drill bit compatible SDS-max

Speeduster SDS-max drill bit enables immediate and total dust removal. The suction system allows faster drilling time.

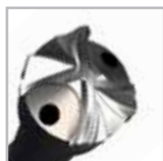

• 2 IN 1 : DRILLING AND VACUUM

Features

- 2 holes for suction dust.
- Centering point.
- Vacuum connector.
- Carbide head.

Benefits

- Working without dust.
- Drilling and cleaning hole in one operation.
- Drilling concrete with rebar.
- Long life.

Applications

- Fixing steel rebar.
- Clean rooms, hospitals, laboratories...



Reinforced concrete, Concrete, Granit, Stone, Brick

Shank

Hammer drill



Compatible
SDS-max



Ø	WL	TL	Ref.	Gencod	Qty
3 cutting edges					
14	400	610	161D14L0610	3336600192669	1
16	400	610	161D16L0610	3336600192676	1
18	400	610	161D18L0610	3336600192683	1
20	400	610	161D20L0610	3336600192690	1



Ø	WL	TL	Ref.	Gencod	Qty
10 cutting edges					
22	400	610	161D22L0610	3336600192706	1
25	400	610	161D25L0610	3336600192713	1
28	400	610	161D28L0610	3336600192720	1
30	400	610	161D30L0610	3336600192737	1
32	400	610	161D32L0610	3336600192744	1
35	400	610	161D35L0610	3336600192751	1

VIDEO DEMO



Ref.
161DMAX

Sleeve spare part

Connecting sleeve for SDS-max speedster drill bit.



Ref.	Gencod	Qty
SDS-max 161DMAX	3336600192768	1

Power recommendation machine / drill diameter

Using a machine not adapted to the diameter can break the drill bit.

Machine Attachment	Batterie voltage	Joule strike force	Weight in kg	DIAMETER													
				12	14	16	18	20	22	24	26	28	30	32	35		
SDS-max Wired perforator	-	8-9	6-7														
	-	12-13	8-9														
SDS-plus Wired perforator	-	2,5-3,5	2,5-3,5														
	-	3-3,5	3-4														
	-	4-4,5	4,5-5														
SDS-plus Cordless perforator	18	2-3	3-4														
	36	2	3														
	36	3-4	4-5														

Optimal use
 Occasional use
 Not compatible



Sleeve compatible with pipes vacuum ø35 or 40mm.



1

Adapter compatible SDS-max
Ref : 370B



2

Extension with coupling screw
Ref : 371B

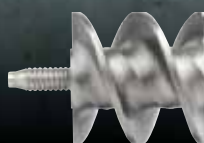

Advices

- Finish to assembly the tool with spanner gripping.
- Regularly lubricate the coupling screws and the threaded bores.
- Put the delivery spring on the femal part (blocking system).

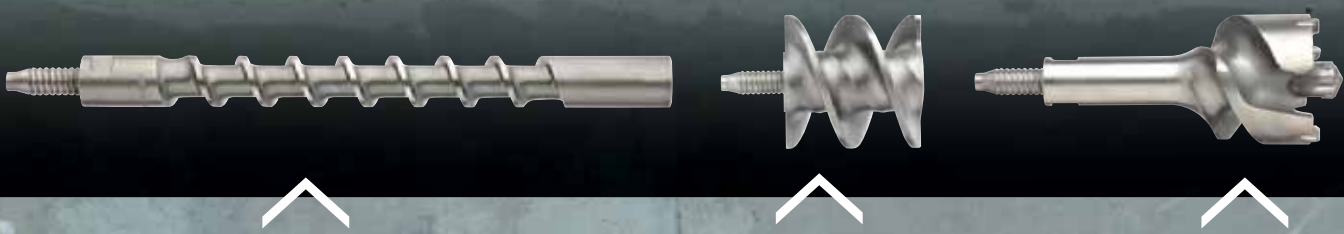

2

Extension with coupling screw
Ref : 371B

3

Spiral with screw
Ref : 372B

4

Head with centering drill bit
Ref : 373B



MODULAR SYSTEM POWER-MAX

Adjustable and upgradeable system for deep drilling more than 1m.

Adapts to all rotary hammer by changing only the adapter.

Capacity to adapt head from Ø45 à 80 mm.

Head with carbide tip and centering drill bit with 3 cutting edges.

- Versatility and modularity.
 - Big diameter.
- Deep drilling up to 1,7 m.

Ref.
373B

Power Max head **POWER-MAX**

Compatible SDS-max



Carbide head with 3 cutting edges and centering drill bit for deep drilling, more than 1m. Capacity to adapt head from ø45 to 80 mm.



- MODULARITY
- DEEP DRILLING

Features

- Adjustable and upgradable system for deep drilling more than 1m.
- Capacity to adapt head from ø45 to 80 mm.
- Head with carbide tip and centering drill bit with 3 cutting edges.

Benefits

- Versatility and modularity.
- Very strong resistance.
- Specially adapted for the drilling of important lengths.

Advices

- Finish tightening the tools with a flat spanner.
- Grease the coupling screws and threaded bores regularly.
- Supplied with spring to be inserted in the female part (locking system).



Concrete, Stone, Breeze block

Attachement Hammer drill



Compatible SDS-max

> 5 KG



Twistpack
Attache européenne
Etiquette couleur

Ø	TL	Ref.	Gencod	Qty
45	150	373BD44	3336600146273	1
55	150	373BD52	3336600143456	1
60	150	373BD60	3336600143463	1
68	150	373BD66	3336600143470	1
80	150	373BD80	3336600143487	1

VIDEO DEMO



Ref.
372B

Power max spiral

Adapted for Power Max head 45 to 60 mm and 68 to 80 mm.



Twistpack
Attache européenne
Etiquette couleur



For head	Ø	TL	Ref.	Gencod	Qt.
45-60	32	115	372BD40	3336600143432	1
68-80	63	115	372BD55	3336600143449	1

Ref.
371B

Power max extension

Power max extension 280 mm include coupling screw and spring.



Twistpack
Attache européenne
Etiquette couleur



Ø	TL	Ref.	Gencod	Qt.
25	280	371BD0280	3336600143425	1

Ref.
370B

Power max adapter SDS-max

Length 185 mm, 400 mm ou 975 mm.



Clip noir



TL	Ref.	Gencod	Qt.
185	370BD0250	3336600143395	1
400	370BD0450	3336600143401	1
975	370BD0850	3336600143418	1

Ref.
375B

Power max coupling screw+spring

Allow to assemble Power Max head, spiral and extension together.



Tube incolore
clip noir



Ø	TL	Ref.	Gencod	Qty
14	63	375B	3336600143500	1



VIDEO DEMO



Sets composition **POWER-MAX**

2 heads



1 spiral



2 extensions



1 adapter

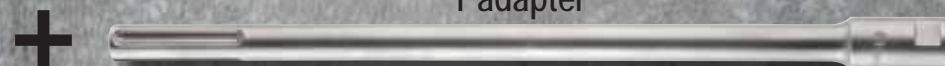

Ref.
090C

Power max set

Power max set ready to use with 2 heads 45 & 55 mm.



Tube Srewpack



Ø 45 x 1000

Spiral Ø 32



Ø 55 x 1000

Spiral Ø 32

Ø	TL	Ref.	Gencod	Qty
46-55	1000	090C	3336600174580	1

Ref.
091C

Power max set

Power max set ready to use with 2 heads 55 & 68 mm.



Tube Srewpack



Ø 55 x 885

Spiral Ø 63



Ø 68 x 1000

Ø	TL	Ref.	Gencod	Qty
55-68	885/1000	091C	3336600186842	1

Ref.
092C

Power max set

Power max set ready to use with 2 heads 55 & 80 mm.



Tube Srewpack



Ø 55 x 885

Hélice Ø 63



Ø 80 x 1000

Ø	TL	Ref.	Gencod	Qty
55-80	885/1000	092C	3336600186859	1

Ref.
165

Crosser



Multi cutting edges drill bit compatible SDS-max



Deep hole drilling from 45 mm up to 80 mm diameter.



- DEEP DRILLING
- LARGE DIAMETERS

Features

- Centering carbide tipped drill.
- Carbide tip in the center and periphery.
- Length 550 to 1125mm.
- SDS-max shank.

Benefits

- High resistance and lifetime.
- Drilling large diameters.
- Destructive power.

Applications

- Ideal for deep or through drilling.



Concrete, Stone, Brick

Shank Hammer drill



Compatible
SDS-max



> 5 KG



Clip noir

Ø	WL	TL	Ref.	Gencod	Qty
L 450 x 550					
45	450	550	165D45L0590	3336600098848	1
55	450	550	165D55L0590	3336600005297	1
68	450	550	165D65L0590	3336600005303	1
80	450	550	165D80L0590	3336600005310	1
L 780 x 1125					
45	780	1125	165D45L0990	3336600005617	1
55	780	1125	165D55L0990	3336600005624	1
68	780	1125	165D65L0990	3336600005631	1
80	780	1125	165D80L0990	3336600005648	1

Ref.
138B

Adapter compatible SDS-max SDS-plus

SDS-max shank SDS-plus chuck.



Twistpack
Attache européenne
Étiquette couleur



Ref.	Gencod	Qty
138B	3336600015661	1



Ref.
143B

Adapter SDS-plus thread 1/2" male

Adapter SDS-plus shank thread 1/2" male, to use with Diager chuck 121K.



Clip noir



Ref.	Gencod	Qty
143B	3336600063990	1



Ref.
177B

Adapter SDS-max thread 1/2" male

Adapter SDS-max shank thread 1/2" male to use with Diager chuck 121K.



Etui transparent



Ref.	Gencod	Qty
177B	3336600064010	1



Ref.
121A

Chuck

Keyless chuck

Features

- Keyless chuck thread 1/2" x 20 mm.
- Range of use 1,5 to 13mm.



Ref.	Gencod	Qty
121A	3336600202412	1

Ref.
124K

Chuck

Keyless chuck thread M14

Features

- Keyless chuck thread M14 special for angle grinder.



Ref.	Gencod	Qty
124K	3336600146938	1



DEMOLITION RANGE HAMMER DRILL

Flat chisel

P. 60

To remove material in larger quantities.

Angled bolster

For removing material in larger quantities with an angled working face for more ergonomic work.

P. 61

Brick chasing chisel

P. 62

For work in sandstone, brick and stone. Ideal for varying the depth of the trench and for digging places for power outlets without changing tools.

Concrete chasing chisel

P. 62

To make thick trench on concrete.

Bush hammer head

P. 61

- 16 carbide teeth.
- Monobloc.



Toothed chisel

P. 61

To unjoint, remove without damaging bricks or masonry stones, tiles and layers of plaster.

Jointed chisel

P. 62

To put out the junctions mortar of bricks,...



Storage bin

For storing demolition tools, delivered in bulk. Removal dividers delivered with the display. Arranged on shelf, bottom of sales shelf. Magnetic bottom for optimal stability. Ref. M00197



Features	Ref.	Gencod
BIN WITH REMOVAL DIVIDER (WIDTH 500 MM X DEPTH 500 MM)	M00197	3336609008909

Ref.
322

Helical pointed chisel compatible SDS-plus

Chisel with helical point which facilitates the destruction of materials, avoids blockages and allows a better efficiency.



Ø	TL	Ref.	Gencod	Qty
Compatible SDS-PWLs				
12	250	322D12L0250	3336600012820	1
14	250	322D14L0250	3336600022171	1

Black plastic clip



Ref.
342

Helical pointed chisel compatible SDS-max

Chisel with helical point which facilitates the destruction of materials, avoids blockages and allows a better efficiency.



Ø	TL	Ref.	Gencod	Qty
Compatible SDS-max				
18	280	342D18L0280	3336600063488	1
18	400	342D18L0400	3336600061521	1
18	600	342D18L0600	3336600063495	1

Black plastic clip



Ref.
318

Flat chisel compatible SDS-plus

High resistance flat chisel for all demolition work.



Width	TL	Ref.	Gencod	Qty
Compatible SDS-PWLs				
20	250	318L20L0250	3336600063518	1
40	200	318L40L0200	3336600063525	1

Black plastic clip



Ref.
343

Flat chisel compatible SDS-max

High resistance flat chisel for all demolition work.



Width	TL	Ref.	Gencod	Qty
Compatible SDS-max				
24	280	343L24L0280	3336600063549	1
24	400	343L24L0400	3336600061514	1
24	600	343L24L0600	3336600075368	1
50	360	343L50L0360	3336600063556	1
80	300	343L80L0300	3336600063563	1
115	350	343L115L0350	3336600063570	1

Black plastic clip



HELICAL WORKING HEAD



**4 ANTI-LOCK
CUTTING EDGES**

**BETTER AIR AND
DUST REMOVAL**

EFFORTLESS DRILLING

Due to its helical head, the Pointed chisel penetrates and explodes easily most materials. The user's efforts are minimised in comparison to a classic head form. User comfort is improved.

ANTI-LOCK

The new helical working head works in half rotation with constant pressure on its 4 cutting edges. Due to its guide and specific geometry which evacuates air and dust during drilling, it does not lock into materials.

100 % POWERFUL

High temperature heat treatment under controlled atmospheric conditions provides maximum strength which concentrates all the machine tool power for a real drilling performance.



Ref.
363

Bush-hammer compatible SDS-max

Bush-hammer monobloc head with 16 carbide teeth.



Twistpack

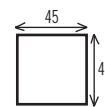

Width	TL	Ref.	Gencod	Qty
Compatible SDS-max				
45	240	363D16L0045	3336600063723	1



Ref.
348

Elbowed chisel compatible SDS-plus



Black plastic clip

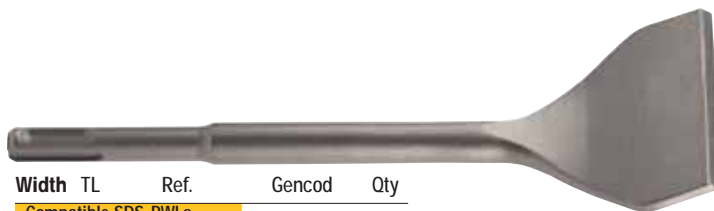

Width	TL	Ref.	Gencod	Qty
Compatible SDS-PWls				
40	200	348L40L0200	3336600063648	1
80	200	348L80L0200	3336600192430	1



Ref.
349

Elbowed chisel compatible SDS-max



Black plastic clip



Width	TL	Ref.	Gencod	Qty
Compatible SDS-max				
50	300	349L50L0300	3336600063655	1
80	300	349L80L0300	3336600185401	1



Ref.
361

Carbide tipped chisel compatible SDS-max



Black plastic clip



Width	TL	Ref.	Gencod	Qty
Compatible SDS-max				
38	280	361L40L0280	3336600063662	1



Ref.
329

Jointed chisel compatible SDS-max

High resistance steel.



Black plastic clip



Thickness	TL	Ref.	Gencod	Qty
Compatible SDS-max				
10	300	329L10L0300	3336600063679	1



Ref.
311

Chasing chisel compatible SDS-plus

High resistance steel.



Black plastic clip



Thickness	TL	Ref.	Gencod	Qty
Compatible SDS-PWLs				
22	250	311L22L0250	3336600063686	1



Ref.
312

Chasing chisel compatible SDS-max

High resistance steel.



Black plastic clip



Width	TL	Ref.	Gencod	Qty
Compatible SDS-max				
26	300	312L26L0300	3336600063693	1



Ref.
314

Brick chasing chisel compatible SDS-max

High resistance steel.



Black plastic clip



Thickness	TL	Ref.	Gencod	Qty
Compatible SDS-max				
32x23	300	314L32L0300	3336600063709	1
35x36	380	314L35L0380	3336600063716	1





**Made in
GERMANY**

Hexagonal 19 mm + retaining groove (ref.310, 347)

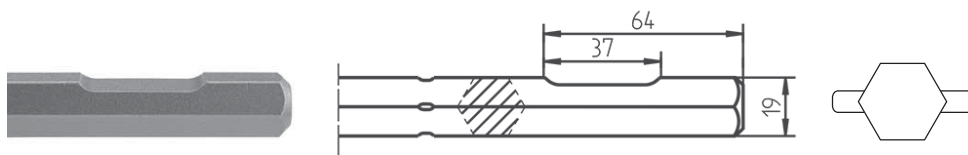

Hexagonal 19 mm + cylindrical tip $\varnothing 16,5 \times 35$ mm (ref.324)

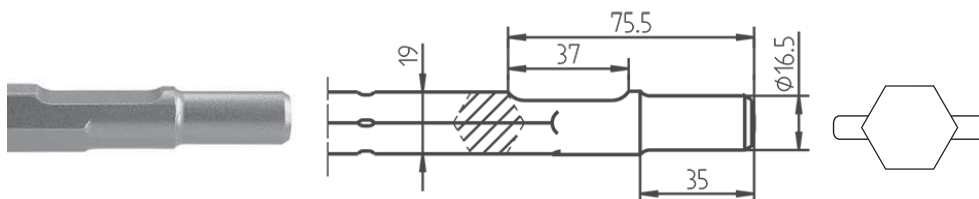

Hexagonal 22 mm + 6 grooves (TE-S) (ref.355, 359)



DEMOLITION RANGE ELECTRIC BREAKER

Pointed chisels, Flat chisels
and shovel chisels



Hexagonal 28 mm + flat (ref.341, 354)

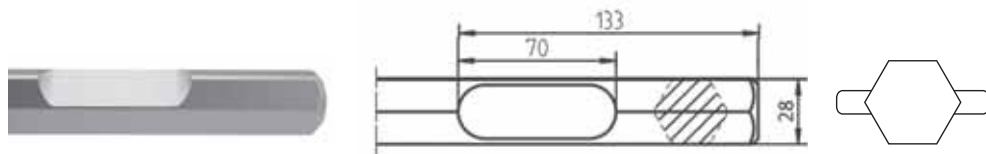

Hexagonal 28 mm + collar (ref.321H, 351H, 373H)

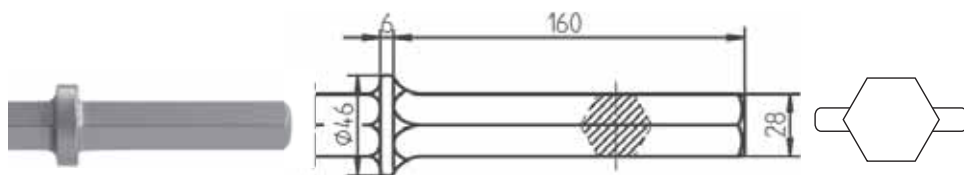

Hexagonal 30 mm + cylindrical tip $\phi 24 \times 55$ mm (ref.393, 394)

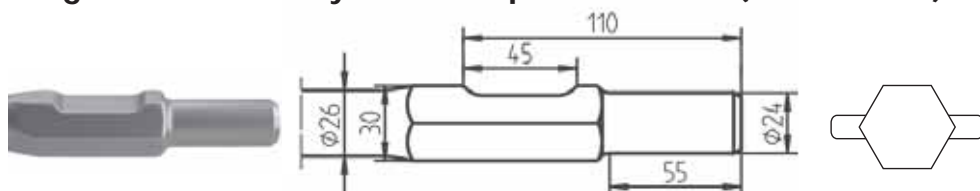

Ref. 310 Pointed chisel hexagonal 19 mm with 37 mm flat spot



Paperboard

Ø	TL	Ref.	Gencod	Qty
Hexagonal 19 mm + flat				
19	400	310H19L0400	3336600190306	1



Ref. 347 Flat chisel hexagonal 19 mm with 37 mm flat spot



Paperboard

Width	TL	Ref.	Gencod	Qty
Hexagonal 19 mm + flat				
24	400	347L24L0400	3336600190313	1



Ref. 324 Pointed chisel hexagonal 19 mm with cylindrical tip 16,5 x 35 mm



DIY tube

Ø	TL	Ref.	Gencod	Qty
Hexagonal 19 mm + cylindrical tip Ø16.5x35 mm				
19	300	324H19L0300	3336600013148	1
19	400	324H19L0400	3336600013155	1



Ref. 320 Flat chisel hexagonal 19 mm with cylindrical tip 16,5 x 35 mm



DIY tube

Width	TL	Ref.	Gencod	Qty
Hexagonal 19 mm + cylindrical tip Ø16.5x35 mm				
24	300	320L24L0300	3336600063587	1
24	400	320L24L0400	3336600063594	1
80	300	320L80L0300	3336600063617	1



Ref.
359

Pointed chisel hexagonal 22 mm
with 6 grooves TE-S



Ø	TL	Ref.	Gencod	Qty
Hexagonal 22mm + 6 grooves (TE'S)				
22	360	359D22L0360	3336600173392	1



Ref.
355

Flat chisel hexagonal 22 mm
with 6 grooves TE-S



Width	TL	Ref.	Gencod	Qty
Hexagonal 22mm + 6 grooves (TE'S)				
28	360	355L28L0360	3336600173408	1



Ref.
354

Pointed chisel hexagonal 28 mm
with 70 mm flat spot



Ø	TL	Ref.	Gencod	Qty
Hexagonal 28 mm + flat				
28	400	354H28L0400	3336600171848	1



Ref.
341

Flat chisel hexagonal 28 mm
with 70 mm flat spot



Width	TL	Ref.	Gencod	Qty
Hexagonal 28 mm + flat				
32	400	341L32L0400	3336600173385	1



Ref.
321H

Pointed chisel hexagonal 28 mm with collar



Ø	TL	Ref.	Gencod	Qty
Hexagonal 28x160 mm with collar				
28	560	321HD28L0560	3336600195417	1



Ref.
351H

Flat chisel hexagonal 28 mm with collar



Larg.	TL	Ref.	Gencod	Qty
Hexagonal 28x160 mm with collar				
30	560	351HL30L0560	3336600195424	1
85	520	351HL85L0520	3336600196483	1



Ref.
373HL

Shovel chisel hexagonal 28 mm with collar



Larg.	TL	Ref.	Gencod	Qty
Hexagonal 28x160 mm with collar				
75	560	373HL75L0560	3336600196469	1
125	510	373HL125L0510	3336600196476	1



Ref.
393

Pointed chisel hexagonal 30 mm with cylindrical tip 24 x 55 mm



Tube incolore clip noir

Ø	TL	Ref.	Gencod	Qty
Hexagonal 30 mm + extrémité cylindrique Ø 24x55 mm				
24	400	393D24L0400	3336600083233	1



Ref.
394

Flat chisel hexagonal 30 mm with cylindrical tip 24 x 55 mm



Tube incolore clip noir

Width	TL	Ref.	Gencod	Qty
Hexagonal 30 mm + cylindrical tip Ø24x 55 mm				
32	400	394L32L0400	3336600083219	1
75	400	394L75L0400	3336600083202	1



Electric breaker & attachments compatibility

 <p>Hexagonal 19 mm + flat</p>	 <p>Hexagonal 19 mm + cylindrical tip Ø16.5x35 mm</p>	 <p>Hexagonal 22 mm + grooves (TE-S)</p>	 <p>Hexagonal 28 mm + flat</p>	 <p>Hexagonal 30 mm + cylindrical tip Ø24x55 mm</p>	 <p>Hexagonal 28 mm + collar</p>
ATLAS COPCO	ATLAS COPCO	HILTI®	BOSCH®	BOSCH®	HITACHI® / HIKOKI®
PB14D	PB10H	TE805	GSH16-28	GSH16-30	H90 SG
BOSCH®	PH11H	TE905	GSH27	HITACHI® / HIKOKI®	MAKITA®
PH5H	TE905AVR	TE905AVR	GSH27VC		
HS10 (12312)	PHE50H	TE1000AVR	HS10 (12312)		HM1317CB
USH10 (11305)	PHE5H	TE1500AVR	USH27 (11304)	H65SB	HM1812
CASALS®	PHE6H	TE2000AVR	11335K	H65SB2	HM1512
Tornado	BOSCH®	TE800AVR	BH2760VC	H70 SA	
			BH2770VCD	H655B3	
DEWALT®	45DE (11214)		DEWALT®	MAKITA®	
	UBH12-50 (11209)				
D25940K	UBH6-35		D25980	HM1300	
D25941K	UBH6-35D		D25987A	HM1303	
DW558K	USH6		D2560K	HM1304	
ELU®	HITACHI® / HIKOKI®		HILTI®	HM1317C	
SH60K			TE3000	HM1400	
HITACHI® / HIKOKI®	H45FRV		HITACHI® / HIKOKI®	MILWAUKEE®	
	DH38YA				
	DH38YF				
DH50SH1	DH40FA		H65 SD	K2628H	
KANGO	DH40FB		H70 SD	K1528H	
	DH40FR		H85	K1530H	
	DH50SB		H90 SE	D25961K	
1400B	DH50SBK		MILWAUKEE®		
638S	MAKITA®				
800S					
900B	HM0810B		K2628H		
900KS	HM1140C		K1528H		
900S	HM1242C		MAKITA®		
900XS	HR3520B		HM1304B		
950B	HR3850B		HM1500B		
MAKITA®	HR4040C		HM1511		
HM1200B	HR5000				
MILWAUKEE®	METABO®				
	Bh1130S				
5335	Bh1131S				
RYOBI®	BhE6030S				
	RH66				
CH465K	RH99				
CH486K	RH99X				
SPIT®	MILWAUKEE®				
400	5311				
400S	5312				
	5316				
	5317				
	5343				
	5344				
	5347				
	5348				
	5352				
	5353				
	PH11H				
	PH40H				
	WACKER®				
	EBH11BLS				

DIAMANT CONCEPT

Diamond core bit exhibition

Dimensions :
H 1400 x L 1000 x P 500 mm
Concept on wheels,
can be positioned
on sales shelf head or on island
in a self-service area

Storage area
Accessories and Adapters

Flyers Informations

Space dedicated for
refilling demand

Storage area
Machines

Storage area
Box for return
core bit



OR TO INTEGRATE
ON SALES SHELF

1M support to present diamond core bits.
Choice of hooks according to attachment : 1/2" & 1-1/4".

Designation	Ref.	Gencod
CONCEPT FURNITURE DIAMOND	M00160	3336609005991
SUPPORT FOR DIAMOND CORE BIT (to attribute with 1 BAR1000)	M00150	3336609004468
HOOK FOR CORE BIT 1/2"	M00122	3336609004338
HOOK FOR CORE BIT 1-1/4"	M00123	3336609004345

Core drilling manual

Selecting tools



Hardware compatibility

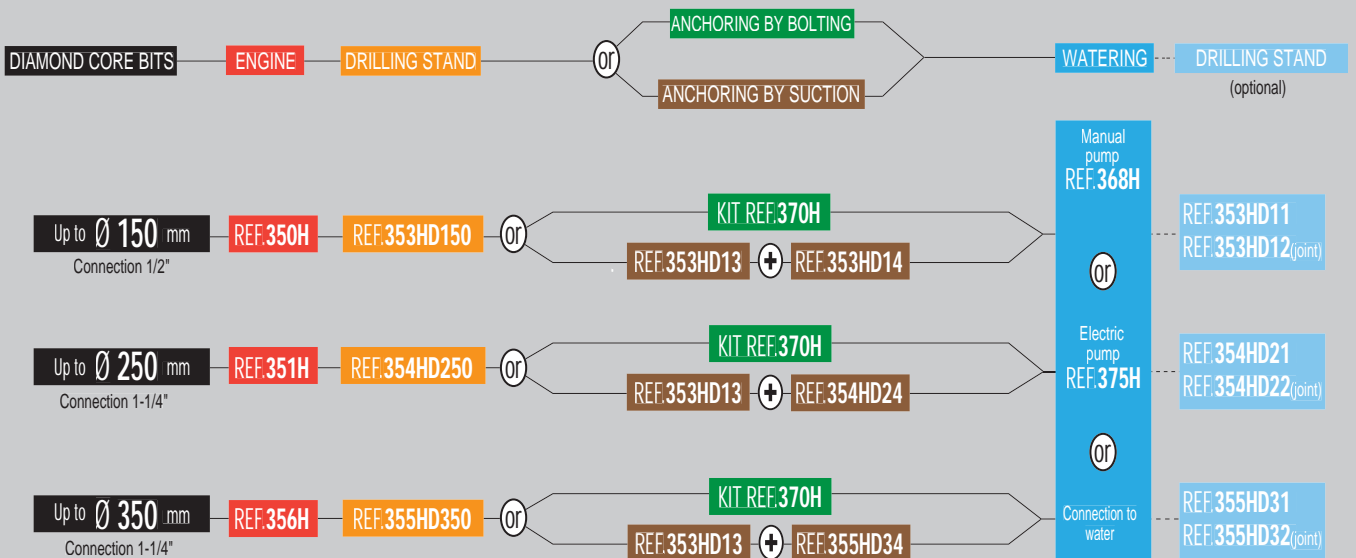

Ref.
436A

Diamond core bit

Diamond core bit 1/2" male

High performance diamond core bit for concrete and building materials.



- 3 TIMES MORE HOLES
- TWICE LESS WEAR

Features

- Corrugated segment.
- High diamond concentration.
- Coated diamond grit.

Benefits

- Drilling reinforced concrete.
- Wavy segment reduce friction and optimize drilling effort.

Applications

- Passage of electric ducts, exhaust pipes or ventilation ducts.

Advices

- For a constant efficiency and better lifespan use the sharpening stone ref 441.



Reinforced concrete, Concrete, Stone, Granit, Brick

Shank



Compatible connection 1/2"

Use



Watering



ON REQUEST

- Connection 3 holes Ref. 436c
- Other length
- Specifics materials



VIDEO TUTO



Ø	WL	Ref.	Gencod	Qty
Connection 1/2" - WL 400				
30	400	436AD030L0400	3336600158238	1
35	400	436AD035L0400	3336600144965	1
40	400	436AD040L0400	3336600144972	1
46	400	436AD046L0400	3336600144989	1
51	400	436AD051L0400	3336600174627	1
56	400	436AD056L0400	3336600173927	1
61	400	436AD061L0400	3336600159143	1
66	400	436AD066L0400	3336600174665	1
71	400	436AD071L0400	3336600174146	1
82	400	436AD082L0400	3336600174566	1
87	400	436AD087L0400	3336600176553	1
92	400	436AD092L0400	3336600174542	1
102	400	436AD102L0400	3336600174528	1
112	400	436AD112L0400	3336600158832	1
127	400	436AD127L0400	3336600168206	1
132	400	436AD132L0400	3336600174535	1
152	400	436AD152L0400	3336600175075	1
162	400	436AD162L0400	3336600174559	1
169	400	436AD169L0400	3336600175853	1
200	400	436AD200L0400	3336600173477	1

Ref.
436B

Diamond core bit

Diamond core bit 1-1/4" female

High performance diamond core bit for concrete, concrete with rebar and building materials.



- 3 TIMES MORE HOLES
- TWICE LESS WEAR

Features

- Corrugated segment.
- High diamond concentration.
- Coated diamond grit.

Benefits

- Drilling reinforced concrete.
- Wavy segment reduce friction and optimize drilling effort.

Applications

- Passage of electric ducts, exhaust pipes or ventilation ducts.

Advices

- For a constant efficiency and better lifespan use the sharpening stone ref 441.



Reinforced concrete, Concrete, Stone, Granit, Brick

Shank



Compatible

Use



Watering



connection 1-1/4"



Paperboard

Ø	WL	Ref.	Gencod	Qty
Connection 1-1/4" - WL 450				
46	450	436BD046L0450	3336600174405	1
51	450	436BD051L0450	3336600144996	1
56	450	436BD056L0450	3336600145009	1
61	450	436BD061L0450	3336600145016	1
66	450	436BD066L0450	3336600145023	1
71	450	436BD071L0450	3336600145030	1
76	450	436BD076L0450	3336600145047	1
82	450	436BD082L0450	3336600145054	1
87	450	436BD087L0450	3336600145061	1
92	450	436BD092L0450	3336600145078	1
102	450	436BD102L0450	3336600145085	1
112	450	436BD112L0450	3336600145092	1
117	450	436BD117L0450	3336600145108	1
122	450	436BD122L0450	3336600145115	1
127	450	436BD127L0450	3336600145122	1
132	450	436BD132L0450	3336600145139	1
142	450	436BD142L0450	3336600145146	1
152	450	436BD152L0450	3336600145153	1
162	450	436BD162L0450	3336600145160	1
169	450	436BD169L0450	3336600145186	1
172	450	436BD172L0450	3336600145177	1
182	450	436BD182L0450	3336600145184	1
187	450	436BD187L0450	3336600145451	1
196	450	436BD196L0450	3336600145468	1
200	450	436BD200L0450	3336600145191	1

Ø	WL	Ref.	Gencod	Qty
212	450	436BD212L0450	3336600145475	1
225	450	436BD225L0450	3336600145207	1
226	450	436BD226L0450	3336600145482	1
248	450	436BD248L0450	3336600145499	1
250	450	436BD250L0450	3336600145214	1
266	450	436BD266L0450	33366001454605	1
277	450	436BD277L0450	33366001454612	1
297	450	436BD297L0450	33366001454629	1
300	450	436BD300L0450	3336600145238	1
342	450	436BD342L0450	33366001454636	1
350	450	436BD350L0450	3336600145245	1
353	450	436BD353L0450	33366001454643	1
400	450	436BD400L0450	3336600145252	1

Forsheda® seal compatible

Ref.
439B

Diamond core bit

Diamond core bit 1-1/4" female

High performance diamond core bit for abrasive materials such asphalt and tarmac.



• SPECIAL ASPHALT

Features

- Special asphalt composition.
- High diamond concentration.
- Coated diamond grit.

Benefits

- High resistance in abrasive materials such asphalt and tarmac.

Applications

- For asphalt.

Advices

- For a constant efficiency and better lifespan use the sharpening stone ref 441.



Asphalt

Shank



Compatible

Use



Watering



connection 1-1/4"

Ø	WL	Ref.	Gencod	Qty
Connection 1-1/4" - WL 450				
66	450	439BD066L0450	3336600161832	1
82	450	439BD082L0450	3336600158849	1
92	450	439BD092L0450	3336600158856	1
102	450	439BD102L0450	3336600158863	1
112	450	439BD112L0450	3336600158870	1
117	450	439BD117L0450	3336600196537	1
122	450	439BD122L0450	3336600157668	1
127	450	439BD127L0450	3336600158887	1
132	450	439BD132L0450	3336600158894	1
142	450	439BD142L0450	3336600158900	1
152	450	439BD152L0450	3336600157415	1
162	450	439BD162L0450	3336600158917	1
172	450	439BD172L0450	3336600158924	1
182	450	439BD182L0450	3336600158931	1
196	450	439BD196L0450	3336600158948	1
200	450	439BD200L0450	3336600158955	1
250	450	439BD250L0450	3336600192607	1
266	450	439BD266L0450	3336600174573	1



Paperboard

VIDEO TUTO



Ref.
RESEG

Diamond core bit

Reloading

When your diamond core bit is worn our after sale service assure reloading.
Contact us for more information.



• AFTER-SALES SERVICE

Reloading Diamond core bit
• Ø Maximum 450 mm.

Return adress
SAV Couronne - Batiment 4
Rue Roger Thirode - 39800 Poligny France.
• Phone number : +33 3 84 73 74 75.
• Fax : +33 3 84 73 74 74.

Segment



Wavy or straight

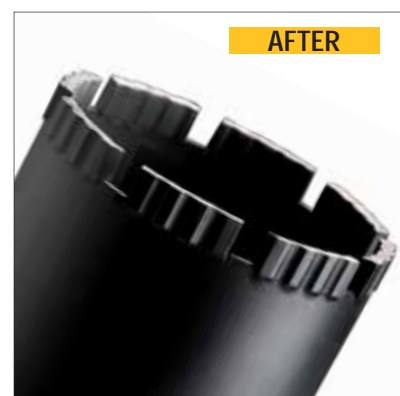
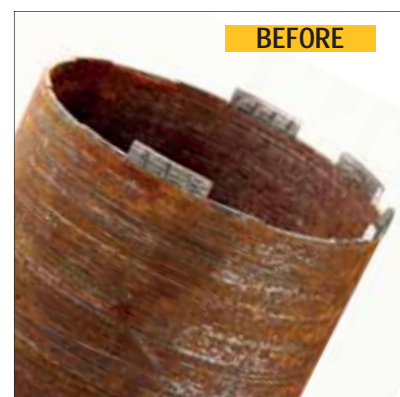

Ref.	Gencod	Qty	Ref.	Gencod	Qty
Wavy segment			Straight segment		
RESEGM436D030	3336600175730	1	RESEGM436D225	3336600175488	1
RESEGM436D035	3336600175303	1	RESEGM436D226	3336600176591	1
RESEGM436D040	3336600175310	1	RESEGM436D248	3336600175778	1
RESEGM436D046	3336600175747	1	RESEGM436D250	3336600175495	1
RESEGM436D051	3336600175327	1	RESEGM436D266	3336600176607	1
RESEGM436D056	3336600175334	1	RESEGM436D275	3336600175785	1
RESEGM436D061	3336600175341	1	RESEGM436D277	3336600176614	1
RESEGM436D066	3336600175358	1	RESEGM436D297	3336600176621	1
RESEGM436D071	3336600175365	1	RESEGM436D300	3336600175501	1
RESEGM436D076	3336600175754	1	RESEGM436D342	3336600176638	1
RESEGM436D082	3336600175372	1	RESEGM436D350	3336600175518	1
RESEGM436D087	3336600175617	1	RESEGM436D353	3336600175792	1
RESEGM436D092	3336600175624	1	RESEGM436D400	3336600176645	1
RESEGM436D102	3336600175389	1			
RESEGM436D112	3336600175396	1			
RESEGM436D117	3336600175402	1			
RESEGM436D122	3336600175419	1			
RESEGM436D127	3336600175426	1			
RESEGM436D132	3336600175433	1			
RESEGM436D142	3336600175631	1			
RESEGM436D152	3336600175440	1			
RESEGM436D162	3336600175457	1			
RESEGM436D169	3336600175648	1			
RESEGM436D172	3336600175464	1			
RESEGM436D182	3336600175655	1			
RESEGM436D187	3336600176577	1			
RESEGM436D196	3336600175761	1			
RESEGM436D200	3336600175471	1			
RESEGM436D212	3336600176584	1			

Ref.
350H

Drilling motor

Diamond drilling machine 2000W combi 1/2" female 1-1/4" male

Features

- Power 2000W.
- Electrical overload indication.
- Ø max drill concrete 150 mm and max drill brick 200 mm.

- Drill connection 1/2" female and 1-1/4" male.
- Weight 6,5 kg.

Benefits

- 3 speeds : 450-1050-2000 RPM.
- Soft grip for less vibration and anti skid.



Shank



Combi 1/2" Female and 1-1/4" Male



Plastic case

Ref.	Gencod	Qty
350H	3336600155169	1

AFTER-SALES SERVICE

Motors and Drilling stand

An engine failure, a broken part, our after-sales service ensures the repair and the supply of spare parts.

To obtain a quote or a support form, contact our ADV department directly.

Phone number : +33 3 84 73 69 22 - Fax : +33 3 84 73 74 74

VIDEO TUTO



Ref.
398H

Drilling motor

Hand drilling motor 2000 W combi 1/2" female 1-1/4" male

Features

- Power 2000W.
- Electrical overload indication.
- Ø max drill concrete 150 mm and max drill brick 200 mm.

- Drill connection 1/2" female and 1-1/4" male.
- Weight 7,5 kg.

Benefits

- 3 speeds : 450-1050-2000 RPM.
- Soft grip for less vibration and anti skid.



Shank



Combi 1/2" Female and 1-1/4" Male



Plastic case

Ref.	Gencod	Qty
398H	3336600190085	1

Ref.
351H

Drilling motor

Diamond drilling machine 2500W 1-1/4" Male

Features

- Power 2500W.
- Electrical overload indication.
- Ø max drill concrete 250 mm.

- Drill connection 1-1/4" male.
- Weight 11,5 kg.

Benefits

- 3 speeds : 200-400-950 RPM.
- Waterflow indicator



Shank



Compatible
1-1/4" Male



Paperboard

Ref.	Gencod	Qty
351H	3336600155176	1

Ref.
356H

Drilling motor

Diamond drilling machine 3400W 1-1/4" Male

Features

- Power 3400W.
- Electrical overload indication.
- Ø max drill concrete 350 mm.
- Drill connection 1-1/4" male.
- Weight 12,5 kg.

Benefits

- 3 speeds : 230-520-965 RPM.
- Equipped with quadruple security; electronic (1) and mechanical clutch (2), PRCD

switch (3) and start current limiter (4).



Shank



Compatible
1-1/4" Male



Paperboard

Ref.	Gencod	Qty
356H	3336600201293	1

Ref.
353H

Drilling stand

Drilling stand capacity 150 mm

Features

- For drill motor 2000W.
- Max Ø of drilling: 150 mm.
- Dimensions: 45 x 23 x 90 cm.
- Weight: 8 kg.

VIDEO TUTO



Carton

Ref.	Gencod	Qty
353HD150	3336600155206	1

S.A.V

Moteurs et Bâtis

Une panne moteur, une pièce cassée, notre service après vente assure la réparation et la fourniture de pièces détachées. Pour obtenir un devis ou un formulaire de prise en charge, contactez directement notre service ADV.

Tél : +33 (0)3.84.73.69.22 - Fax : +33 (0)3.84.73.74.74



Ref.
354H

Drilling stand

Drilling stand capacity 250 mm

Features

- For drill motor 2500W and 3400W.
- Max Ø of drilling: 250 mm.
- Dimensions: 46 x 27 x 120 cm.
- Weight: 15 kg.



Carton

Ref.	Gencod	Qty
354HD250	3336600155213	1



Ref.
355H

Drilling stand

Drilling stand capacity 350 mm

Features

- For drill motor 2500 and 3400W.
- Max Ø of drilling: 350 mm.
- Dimensions: 46 x 27 x 120 cm.
- Weight: 22 kg.



Carton

Ref.	Gencod	Qty
355HD350	3336600155220	1



Ref.
356E

Diamond equipment pack 2000W



Ref.	Gencod	Qty
356E	3336600173149	1

Ref.
399H

Anchoring set for drilling stand



Ref.	Gencod	Qty
399H	3336600197565	1

ADVICES

- Manual drilling: $\varnothing 82$ mm maximum.
- After use: Let the machine run with no load for 1 minute.
- Use 1 electric extension with a section of 3x4.5 mm minimum.

Recommended rotation speed according to the maximum \varnothing to drill			
Speed selector	350H and 398H (2000W)	351H (2500W)	356H (3400W)
1	Brick > $\varnothing 150$ mm	> $\varnothing 250$ mm	> $\varnothing 350$ mm
2	Brick > $\varnothing 80$ mm	> $\varnothing 125$ mm	> $\varnothing 250$ mm
3	Brick > $\varnothing 40$ mm	> $\varnothing 85$ mm	> $\varnothing 150$ mm



Ref.
370H

Diamond drilling accessories - Anchoring
M12 tensioning spindle.



Envelope Label



Ref.	Gencod	Qty
370H	3336600156845	1

Ref.
F71

Diamond drilling accessories - Anchoring
50 dropin anchor M12x50 mm.



Carton box



Ref.	Gencod	Qty
F71M12050000XX	3336600161641	1

Ref.
F710F

Diamond drilling accessories - Anchoring
Dropin anchor tool for M12x50.



Quality plastic pouch



Ref.	Gencod	Qty
F71M120000000F	3336600161689	1

Ref.
373H

Diamond drilling accessories - Anchoring
Anchoring with prop 290 cm max.



Paperboard



Ref.	Gencod	Qty
373H	3336600156876	1

VIDEO TUTO



Ref. 353HD13 Diamond drilling accessories - Suction fixing



Vaccum set for drilling stand for drilling stand diager 353H - 354H - 355H.



Ref.	Gencod	Qty
353HD13	3336600155299	1

Ref. 375H Diamond drilling accessories - Water use

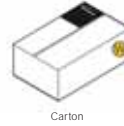

Electric water pump pipe + 2 connections.



Ref.	Gencod	Qty
Pompe 375H	3336600167018	1

Ref. 353HD14 Diamond drilling accessories - Suction fixing



Joint for drilling stand 353H Anchoring by suction rubber joint for drilling stand 353H.



Ref.	Gencod	Qty
353HD14	3336600155329	1

Ref. 368H Diamond drilling accessories - Water use



Plastic water pump manual use.



Ref.	Gencod	Qty
368H	3336600156913	1

Ref. 354HD24 Diamond drilling accessories - Suction fixing



Joint for drilling stand 354H Anchoring by suction rubber joint for drilling stand 354H.



Ref.	Gencod	Qty
354HD24	3336600155336	1

Ref. 353HD11 Diamond drilling accessories - Water collector

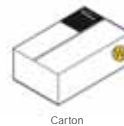

Water collector for stand D150 with rubber joint for drilling stand diager 353H.



Ref.	Gencod	Qty
353HD11	3336600155237	1

Ref. 355HD34 Diamond drilling accessories - Suction fixing



Joint for drilling stand 355H Anchoring by suction rubber joint for drilling stand 355H.



Ref.	Gencod	Qty
355HD34	3336600155343	1

Ref. 354HD21 Diamond drilling accessories - Water collector



Water collector for stand D250 with rubber joint for drilling stand diager 354H.



Ref.	Gencod	Qty
354HD21	3336600155244	1

Ref. 355HD31 Diamond drilling accessories - Water collector



Water collector for stand D350 with rubber joint for drilling stand diager 355H.



Ref.	Gencod	Qty
355HD31	3336600155251	1

Ref. 369H Diamond drilling accessories - Machine adapter



Adapter 1/2» G-5/4» male.



Ref.	Gencod	Qty
369H	3336600156944	1

Ref. 353HD12 Diamond drilling accessories - Water collector



Rubber joint for item 353HD11 for water collector Diager 353HD11.



Ref.	Gencod	Qty
353HD12	3336600155268	1

Ref. 381H Diamond drilling accessories - Machine adapter



Adapter for DD-BI 1-1/4» male for hilti machine DD 80/100/110/120/130/150.



Ref.	Gencod	Qty
381H	3336600156982	1

Ref. 354HD22 Diamond drilling accessories - Water collector



Rubber joint for item 354HD21 for water collector Diager 354HD21.



Ref.	Gencod	Qty
354HD22	3336600155275	1

Ref. 382H Diamond drilling accessories - Machine adapter



Adapter 1/2» female 1-1/4» male for hilti machine DD 160/250/400/750.



Ref.	Gencod	Qty
382H	3336600156968	1

Ref. 355HD32 Diamond drilling accessories - Water collector

VIDEO TUTO



Rubber joint for item 355HD31 for water collector Diager 355HD31.



Ref.	Gencod	Qty
355HD32	3336600155282	1



Ref. 385H Diamond drilling accessories - Machine adapter



Adapter 1/2» female 1-1/4» male for hilti machine DD200/350/500.



Ref.	Gencod	Qty
385H	3336600156975	1

Ref. **390H** Diamond drilling accessories
- Machine adapter



Adapter 1/2» female 1-1/4» female.



Ref.	Gencod	Qty
390H	3336600156951	1

Ref. **392H** Diamond drilling accessories



Chaise adapter collar 60 mm for motor 1800 & 2000 watts on drilling stand D250 and D350.



Ref.	Gencod	Qty
392H	3336600157019	1

Ref. **394H** Diamond drilling accessories
- Machine adapter



Adapter 1/2» female - 1/2» female.



Ref.	Gencod	Qty
394H	3336600178670	1

Ref. **441** Diamond drilling accessories

Sharpening stone Ø 250



Ref.	Gencod	Qty
441	3336600158757	1

Ref. **383H** Diamond drilling accessories
- Extension

Extension 200 mm 1/2» male.



Ref.	Gencod	Qty
383H	3336600156999	1

Ref. **393H** Diamond drilling accessories

Spacer block 60 mm for drilling stand diager 354H and 355H.



Ref.	Gencod	Qty
393H	3336600173811	1

Ref. **384H** Diamond drilling accessories
- Extension

Extension 300 mm 1-1/4» male.



Ref.	Gencod	Qty
384H	3336600157002	1

Ref. **397H** Diamond drilling accessories

Disassembly ring 1-1/4».



Ref.	Gencod	Qty
397H	3336600156920	1

Ref.
431

Diamond core bit

M16 connection

Diamond core bit for dry use.



- ROBUSTNESS
- VERSATILITY

Features

- Corrugated segment.
- Working length 66 mm.

Benefits

- Dry use.
- Use on a drilling machine without percussion.

Advices

- Use on a drilling machine, recommended speed 2500 rpm.



Concrete, Breeze block, Brick, Hollow brick, Cellular concrete, Ceramic tile

Shank Wavy segment



ALL SETS
PAGES 126-127

x4



431C



Black plastic clip

Ø	WL	Ref.	Gencod	Qty
TL 88				
68	66	431D68	3336600145832	1
82	66	431D82	3336600145849	1



Implementation



1/ Pre-drill with Ø8 on the desired depth.
2/ Fit the bit on the adapter and insert the centering guide.

3/ Place the centering guide with the bit in the pre-hole in order to begin coring.

4/ Drill to the desired depth.

VIDEO DEMO



Ref.
432

Diamond core bit with long length and M16 connection

Diamond core bit for dry use.



Ø	WL	Ref.	Gencod	Qty
TL 181				
29	154	432D29	3336600145856	1
35	154	432D35	3336600145863	1
42	154	432D42	3336600145870	1
52	154	432D52	3336600145887	1
65	154	432D65	3336600145894	1



Ref.
433

Hexagonal adapter M16 x 100 mm

Use it with ref 431, 432 and 366.



TL	Ref.	Gencod	Qty
Hexagonal core bit adapter			
100	433L0100	3336600145900	1
220	433L0220	3336600146112	1
320	433L0320	3336600146129	1



Ref.
367

Compatible SDS-Plus core bit adapter

M16 connection and compatible SDS-plus, for core bit 431, 432 et 366.



TL	Ref.	Gencod	Qty
Compatible SDS-PWLs core bit			
100	367L0100	3336600063891	1
170	367L0170	3336600063907	1
220	367L0220	3336600063914	1
320	367L0320	3336600063921	1



Ref.
420

Centering guide 8x120 mm

Have to be fix on the center of the diamond core bi. Use it with ref 431, 432. Remove it just after started the hole.



Ø	TL	Ref.	Gencod	Qty
Centering guide				
8	120	420D08L0120	3336600173699	1
8	210	420D08L0210	3336600173705	1



Ref.
427

Sharpening stone

Sharpening stone 200 x 100 mm for diamond core bit 431 & 432.



TL	Ref.	Gencod	Qty
Sharpening stone			
200	427	3336600155084	1



CRUSHER

CARBIDE CORE BITS COMPATIBLE SDS-PLUS

SIMPLE USE FOR INTENSIVE WORK !



Copper brazed carbide teeth for heat resistance up to 1200 degrees. Patented technology to keep dust away from the inserts.

PRATICE

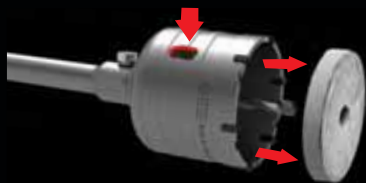

Easy core extraction thanks to oblong drain hole.

EASY



Easy removal of the centring drill with a hexagonal key via the hexagonal screw and of the bit holder with an adjustable spanner via the flat.

KIT

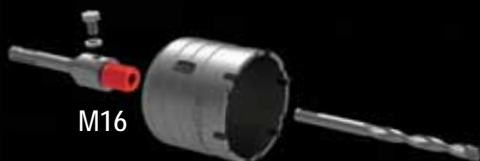

M16

Core bits and accessories available separately or as a complete kit assembled and ready for use.



CARBIDE CORE BIT WITH M16 ATTACHMENT FOR LARGE-DIAMETER DRILLING.

Its high quality steel and carbide and its patented dust-release technology close to the teeth giving it extreme durability and optimal drilling speed. Ideal for electrical and plumbing work: installing electrical boxes, pipe routing.



VIDEO DEMO



Ref.
325C

new



Core bit kit **CRUSHER**

Core bit + drill bit holder with ready-to-use centering

Description

- Premium carbide teeth brazed with copper at high temperature.
- High strength treated steel.
- Patented technology for releasing dust near the pads.
- Drilling depth 50mm.
- Oblong core evacuation hole.
- M16 attachment.

Benefits

- Ideal for large diameter drilling.
 - Extreme lifespan.
- High drilling speed.
- Practicality of use:
significant useful length,
dismantling possible, easy
carrot extraction.
d'extraction de la carotte.

Applications

- Box installation electrical in the masonry.



Concrete, Stone, Brick, Breeze block, Hollow brick

Connexion



Compatible SDS-plus

Hammer drill

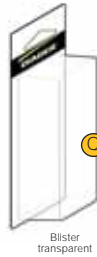

Blister transparent

Ø	Ref.	Gencod	Qt.
Core bit kit			
40	325CD40	3336600207707	1
50	325CD50	3336600207714	1
66	325CD66	3336600207721	1
68	325CD68	3336600207738	1
80	325CD80	3336600207745	1

Ref.

360



Core bit **CRUSHER**

SDS-plus compatible M16 attachment



Twispack incolore

Ø	WL	TL	Ref.	Gencod	Qty
Trepan					
30	50	72	360D30	3336600207752	1
35	50	72	360D35	3336600207769	1
40	50	72	360D40	3336600207776	1
45	50	72	360D45	3336600207783	1
50	50	72	360D50	3336600207790	1
60	50	72	360D60	3336600207806	1
66	50	72	360D66	3336600207813	1
68	50	72	360D68	3336600207820	1
70	50	72	360D70	3336600207837	1
80	50	72	360D80	3336600207844	1
85	50	72	360D85	3336600207851	1
90	50	72	360D90	3336600207868	1
105	50	72	360D105	3336600207875	1
125	50	72	360D125	3336600207882	1
130	50	72	360D130	3336600207899	1

Ref.
362

Bit holder
M16 connection and SDS-plus compatible



Ref.
374

Centering drill **CRUSHER**
Carbide bit holder accessories



Clip noir

TL	Ref.	Gencod	Qty
Compatible SDS-Plus core bit adapter			
105	362L0105	3336600207905	1
170	362L0170	3336600207912	1
220	362L0220	3336600207929	1
320	362L0320	3336600207936	1



Tube incolore clip noir

Ø	LW	TL	Ref.	Gencod	Qt.
Centering drill bit					
8	65	100	374D08L0105	3336600208933	1

CRUSHER

CARBIDE CORE BITS COMPATIBLE SDS-MAX

SIMPLE USE FOR INTENSIVE WORK !



Thick carbide teeth brazed to copper for resistance up to 1200 degrees Celsius.

PRATICE

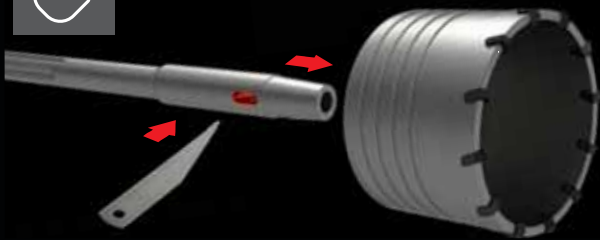

Easy to dismantle with extraction kit ref 303

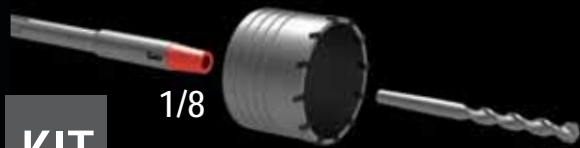

KIT

1/8

Drill bits and accessories available separately or as a complete kit assembled and ready for use.



CARBIDE CORE BIT WITH 1/8" CONICAL ATTACHMENT FOR LARGE DIAMETER DRILLING

Carbide core bits made of high-strength steel with high-temperature copper brazed carbide teeth at high temperatures for fast drilling fast drilling and good wear resistance. Suitable for power drills over 950W.



VIDEO DEMO



Ref.
300C

Drill bit kit **CRUSHER**

Drill bit + Lg 420mm bit holder SDS-max compatible + drill bit

Description

- Premium carbide teeth brazed with copper at high temperature.
- High strength treated steel.
- Drilling depth 75mm.

Benefits

- Ideal for large diameter drilling.
- Very high performance and robustness.

Applications

- Major sanitary and renovation works.

Advices

- During assembly, ensure that the bit is locked onto the cone of the bit holder.
- Carry out a pre-drill using only the centering drill.

new



Concrete, Stone, Brick, Breeze block

Connexion tapered



Compatible SDS-max

Hammer drill



Twistpack Incolore

Ø	Ref.	Gencod	Qt.
Core bit kit			
100	300CD100	3336600197312	1
125	300CD125	3336600197329	1

Ref.
300

Carbide bit **CRUSHER**

SDS-max compatible tapered attachment



Twistpack Incolore

Ø	WL	TL	Ref.	Gencod	Qty
Core bit					
30	75	100	300D30	3336600016088	1
35	75	100	300D35	3336600016095	1
40	75	100	300D40	3336600012745	1
45	75	100	300D45	3336600016101	1
50	75	100	300D50	3336600016118	1
60	75	100	300D60	3336600012752	1
66	75	100	300D66	3336600012769	1
68	75	100	300D68	3336600187122	1
80	75	100	300D80	3336600016132	1
90	75	100	300D90	3336600016149	1
100	75	100	300D100	3336600012776	1
110	75	100	300D110	3336600016156	1
125	75	100	300D125	3336600016163	1
150	75	100	300D150	3336600186118	1

Ref.
330

Bit holder **CRUSHER**

Tapered connection and SDS-max compatible



Clip noir

TL	Ref.	Gencod	Qt.
core bit adapter			
220	330L0220	3336600016194	1
420	330L0420	3336600012790	1
700	330L0700	3336600016200	1
900	330L0900	3336600063969	1

Ref.
302

Centering drill **CRUSHER**

Carbide bit holder accessories



Tube incolore clip noir



Ø	WL	TL	Ref.	Gencod	Qt.
Centring drill bit					
11	90	130	302	3336600012806	1

Ref.
303

Extraction kit **CRUSHER**



Tube Srewpack



Ref.	Gencod	Qt.
Extraction kit		
303	3336600012813	1

CARBIDE HOLE SAW

Range
Ø 19 to 140
mm



▣ ONEHAND PILOT
*Allow quick set up
and quick change.*



▣ CARBIDES TEETH



WOOD, HOLLOW BRICK, PVC, PLASTER



SIMPLE AND FAST ASSEMBLY



Ref. 357L

Carbide hole saw

Multi purpose hole saw carbide tipped teeth with quick lock adapter

Hole saw with carbide tooth set for clean and high performance cutting. Carbide tipped teeth are made of high carbide grade, resulting in outstanding cutting performance and product durability. To be used with the pilot drill bit (onehand system) allowing an important time saving thanks to the locking and unlocking of the saw in only 1 movement.



- VERSATILITY
- SPEED OF USE

Features

- Cutting depth 60 mm.
- High grade carbide teeth.

Benefits

- Large clearance of chips thanks to the specially designed wide slots.
- Smooth cutting with minimal heat build-up.
- Suitable for use in electric and battery powered tools.

Applications

- Installation of sockets, switches, spotlights...

Advices

- Adapt the rotational speed and the centring drill according to the material to be drilled.

VIDEO TUTO



Ø	WL	TL	Ref.	Gencod	Qty
Carbide hole saw					
19	60	90	357LD019	3336600199095	1
20	60	90	357LD020	3336600199101	1
22	60	90	357LD022	3336600199118	1
25	60	90	357LD025	3336600199125	1
29	60	90	357LD029	3336600199132	1
32	60	90	357LD032	3336600199149	1
35	60	90	357LD035	3336600199156	1
38	60	90	357LD038	3336600199477	1
40	60	90	357LD040	3336600199163	1
44	60	90	357LD044	3336600199170	1
51	60	90	357LD051	3336600199187	1
54	60	90	357LD054	3336600199484	1
57	60	90	357LD057	3336600199194	1
60	60	90	357LD060	3336600199200	1
65	60	90	357LD065	3336600199491	1
67	60	90	357LD067	3336600199637	1
68	60	90	357LD068	3336600199217	1
76	60	90	357LD076	3336600199231	1
83	60	90	357LD083	3336600199248	1
89	60	90	357LD089	3336600199255	1
102	60	90	357LD102	3336600199262	1
114	60	90	357LD114	3336600199279	1
127	60	90	357LD127	3336600199286	1
140	60	90	357LD140	3336600199293	1



Blister

Drill and hammer drill

Wood, Hollow brick, PVC, Plaster

Ø	Rotation speed carbide hole saw			
	Wood	Plastic	Plaster	Hollow brick
19-38	800	600	600	600 rpm
40-51	700	450	450	450 rpm
52-76	500	350	350	350 rpm
79-108	300	250	250	250 rpm
111-140	200	150	150	150 rpm

Ref. 357M

Multi purpose hole saw 68 mm with countersink ring and quick lock adapter



Ø	Ref.	Gencod	Qty
68	357MD068	3336600199507	1

Ref.
357A

Pilote onehand hex + HSS drill hexagonal shank 8,5 mm



Blister

Ref.	Gencod	Qty
357AH06.35L125	3336600198968	1

Bois PVC



Ref.
357B

Pilote onehand + carbide drill hexagonal shank 8,5 mm



Blister



Ref.	Gencod	Qty
357BH07L125	3336600198975	1

Brique creuse Plaque de Plâtre



PILOT *COMPATIBLE WITH DIAMOND AND CARBIDE HOLE SAWS*

This pilot with hexagonal 8,5 or SDS-plus shank allow to change of hole saw in a single step. It's only need to clips carbide hole saw with integrated adapter inside the pilot with center drill.



LONG ADAPTER/ ref. 357J *ENLARGE A PRE-EXISTING HOLE*



Allow to use two carbide holes saws simultaneously to improve centering or enlarge a pre-existing hole.

Ref.
357F

HSS drill for onehand pilote



Designation	Ref.	Gencod	Qty
Centring drill bit HSS with flats Ø6,35 mm L125 mm	357FD06.35L0125	3336600199019	1



Ref.
357G

Carbide drill for onehand pilote



Designation	Ref.	Gencod	Qty
Centring drill bit carbide with flats Ø7 mm L125 mm	357GD07L0125	3336600199026	1

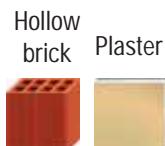

Ref.
357H

3 Connectors onehand hole saw for multi purpose hole saw 19-30 mm



Designation	Ref.	Gencod	Qty
Pack of 3 adapters onehand for carbide hole saw ø19 to 30 mm	357HD14030	3336600199040	1

Ref.
357I

3 Connectors onehand hole saw for multi purpose hole saw 32-140 mm



Designation	Ref.	Gencod	Qty
Pack of 3 adapters onehand for carbide hole saw ø32 to 140 mm	357ID32210	3336600199057	1

Ref.
357J

3 Long connectors for hole saws to connect 2 hole saws on the same connector



2 holes saws Ø19 to 30 mm



1 hole saw Ø19 to 30 mm + 1 hole saw Ø32 to 140 mm



2 holes saws Ø32 to 140 mm

Designation	Ref.	Gencod	Qty
Pack of 3 long adapters onehand allowing to use 2 carbide holes saws simultaneously	357JD14210	3336600199064	1

Ref.
3000C
3000E

Multi purpose hole saw set sizes
Ø22-35-40-51-54-65-68 + pilote + 2 drill bit



Composition	Ref.	Gencod	Qty
Electrician toolcase			
Carbide hole saws (Ø22-35-40-51-54-65-68 mm) + pilot onehand with hexagonal shank 8,5 mm with HSS center drill HSS + 1 carbide center drill + 1 allen key	3000C	3336600199446	1
Plumber toolcase			
Carbide hole saws (Ø19-25-32-38-44-57-68 mm) + pilot onehand with hexagonal shank 8,5 mm with HSS center drill + 1 carbide center drill + 1 allen key	3000E	3336600199453	1

Ref.
3000A
3000B

Multi purpose hole saw kit 68 include pilot and drill bit



Composition	Ref.	Gencod	Qty
Starter kit hole saw Ø68 mm			
1 multimaterials Carbide hole saw Ø68 mm with stop Depth Ø73 mm + onehand pilot with hexagonal shank 8,5 mm and HSS center drill bit	3000A	3336600199415	1
Starter kit hole saw Ø68 - 83 mm			
2 multimaterials Carbide hole saw (Ø68 mm and 83 mm) + onehand pilot with hexagonal shank 8,5 mm and HSS centring drill bit + 1 carbide center drill bit	3000B	3336600199422	1

Ref. 426

Blue Ceram



Blue ceram diamond core bit hexagonal shank

Diamond segment head specially designed for drilling stoneware and hard porcelain tiles.



Tile, Sandstone, Glazed sandstone, Gre-ceram, Sandware terracota, Marble

+ SANDSTONE UP TO CLASS 5

Features

- Head with diamond segment.
- Hexagonal shank.

Benefits

- Drilling stoneware tiles and ceramic.
- Clean hole.

Advices

- For dry use on angle grinder the chuck M14 is needed. Remove the centring flange from the grinder before screwing on the chuck.
- Can be use on a drilling machine without percussion. For more efficiency add a little water.
- Start drilling at 45°.

Shank



Hexagonal

Use



Without percussion



ALL SETS PAGES 126-127

x6



426C

x9



426B

Ø	WL	TL	Ref.	Gencod	Qty
Blue Ceram					
6	22	55	426D06	3336600144415	1
6,5	22	55	426D06.5	3336600157873	1
7	22	55	426D07	3336600144422	1
8	20	55	426D08	3336600144439	1
10	30	65	426D10	3336600144446	1
12	28	65	426D12	3336600144453	1
13	28	65	426D13	3336600157880	1
15	40	70	426D15	3336600144460	1
20	40	70	426D20	3336600144477	1
25	40	70	426D25	3336600144484	1



Plastic box

VIDEO TUTO



VIDEO TUTO



with GRINDER

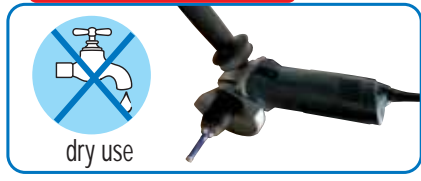

dry use

with DRILL



can be used with a little water for a more effective drilling

Ref.
423

Grey Ceram



Diamond drill bit with M14 attachment

Tool specially designed for drilling all types of tiles, including the hardest, thanks to a head made of premium quality diamond segments. With its M14 shank, the Gray Ceram adapts directly to a grinder where all its cutting potential is exerted thanks to at the high rotational speed of this machine.



• DRILLING THE HARDEST SANDSTONE

Description

- Diamond segment head.
- Extraction throat.
- M14 shank.

Benefits

- Drilling of the hardest sandstones, up to class 5 according to PEI standard and U4 according to UPEC standard.
- Clean, precise and chip-free holes.
- Significant useful length.

Advices

- Use dry on a grinder.
- Always start drilling at 45°.
- Brighten and cool the tool regularly for optimal lifespan.



Tile, Sandstone, Glazed sandstone, Gre-ceram, Sandware terracota, Marble

Shank



M14

Use



without
percussion

Grinder



Tube Srewpack

Ø	WL	TL	Ref.	Gencod	Qty
Grey Ceram					
6	40	80	423D06	3336600205659	1
7	40	80	423D07	3336600205673	1
8	40	80	423D08	3336600205680	1
10	45	80	423D10	3336600205697	1
12	45	80	423D12	3336600205703	1
13	45	80	423D13	3336600205710	1
15	45	80	423D15	3336600205727	1
20	80	80	423D20	3336600205734	1
25	80	80	423D25	3336600205741	1

Ref.
426E

Hexagon adapter - M14

Allows you to adapt an M14 shank tool to a drill.



Drill



Shank



M14

VIDEO DEMO



Tube Srewpack



Ref.	Gencod	Qt.
Adapter M14		
426E	3336600206045	1

DIAMOND HOLE SAW



Range
Ø 30 to 83
mm



■ **DIAMOND**
High quality



CERAMIC, GRANITE, MARBLE



GRINDER

Screw directly on grinder with M14 fitting



 To avoid any risk of injury wait the complete stop of the machine before removing the tool.



DIAMOND HOLE SAWS
Ø30 to 83mm



*without adapter
without pilot*

SIMPLE AND FAST ASSEMBLY

Can be used on a drill via an adapter and a pilot (onehand system). With drilling speed up to 1500 rpm.

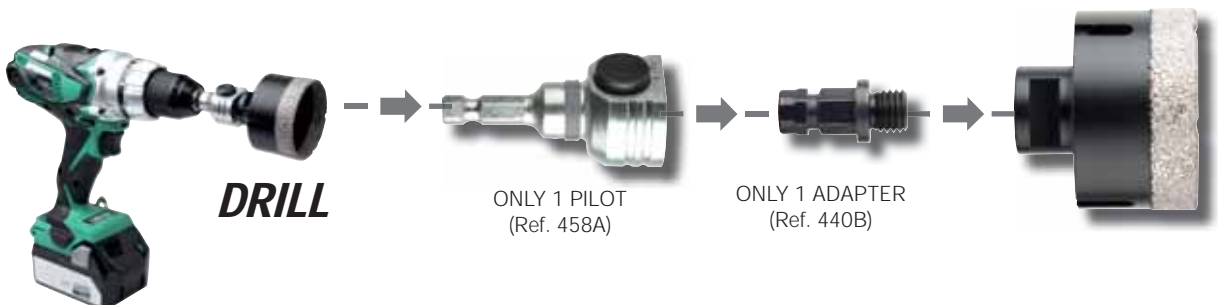

DRILL

ONLY 1 PILOT
(Ref. 458A)

ONLY 1 ADAPTER
(Ref. 440B)

Ref.
440C

Diamond hole saw

M14 connection

Diamond grit edge hole saws specially developed for dry drilling in extremely hard materials.



- VERSATILITY
- DRY DRILLING

Features

- M14 thread for angle grinder.
- Premium grade diamond grit.

Benefits

- Cutting depth 35 mm.
- Dry drilling.
- Clean edges and fast accurate cuts.

Advices

- Start the drilling at 45°.
- Recommended drilling speed > 1500 rpm.
- To avoid the risk of injury, wait until the machine has come to a complete stop before removing the tool from the hole.



Tile, Sandstone, Glazed sandstone, Gre-ceram, Sandware terracota, Marble

Shank



Use



Without percussion



Dry use

Grinder



Blister

Ø	WL	TL	Ref.	Gencod	Qty
Diamond hole saw					
30	35	60	440CD030	3336600199309	1
35	35	60	440CD035	3336600199316	1
40	35	60	440CD040	3336600199323	1
45	35	60	440CD045	3336600199330	1
51	35	60	440CD051	3336600199347	1
55	35	60	440CD055	3336600199354	1
60	35	60	440CD060	3336600199361	1
68	35	60	440CD068	3336600199378	1
73	35	60	440CD073	3336600199385	1
76	35	60	440CD076	3336600199392	1
83	35	60	440CD083	3336600199408	1

VIDEO TUTO



Ref. **440A** Diamond hole saw center drill to use with a drilling machine



Designation	Ref.	Gencod	Qty
Onehand diamond hole saw center drill L= 110 Ø8 mm for marble, tiles and wall	440AD08L110	3336600199033	1



Ref. **440B** Diamond hole saw M14 adapter to use with the center drill on drilling machine



Designation	Ref.	Gencod	Qty
Onehand diamond adapter 3 pcs for diamond hole saw with M14 shank Ø30 à 83 mm	440BD05132	3336600199071	1



Ref. **358A** Pilot onehand hexagonal to use on a drilling machine



Designation	Ref.	Gencod	Qty
Pilot onehand HEX Hexagonal pilot 8,5 mm	358AH08.5	3336600199002	1



PILOT
COMPATIBLE WITH DIAMOND
AND CARBIDE HOLE SAWS

This pilot with hexagonal 8,5 shank allow to change of hole saw in a single step. It's necessary to screw an adapter (440B) on the diamond hole saw, then clips it inside the pilot.



CENTER DRILL / réf.440A
PRE-DRILLING PILOT HOLE

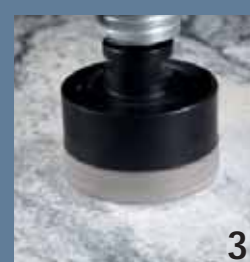
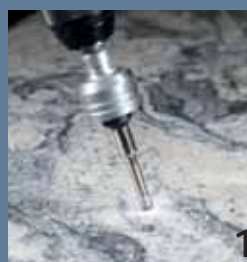

1. Pre-dill a hole with the center drill. 2. Then set up simultaneously drill and hole saw (remove previously the adapter from the drill) on the onehand pilot. 3. Drill using the pre-hole.

Ref.
4400A

Diamond hole saw set

Diamond grit edge hole saws kit specially developed for dry drilling in extremely hard materials.

Features

- M14 thread for angle grinder.
- Premium grade diamond grit.
- Side holes for release of slurry.
- Cutting depth 35mm.

Benefits

- Dry drilling.
- Clean edges and fast accurate cuts.
- Ideal for tiles, granite and hard stone.

Advices

- Start the drilling at 45°.
- Recommended drilling speed >1500 rpm.
- To avoid the risk of injury, wait until the machine has come to a complete stop before removing the tool from the hole.



Composition	Ref.	Gencod	Qty
Diamond set			
4 diamond hole saw (ø35-45-51-68mm).	4400A	3336600201682	1

Ref.
440S

Diamond centering guide

Suction cup guide for horizontal and vertical drilling. Provides perfect centring. Ideal for drilling without marking. For diamond drills and diamond saws ø4 to 80 mm.

Features

- Drilling from ø4 to 80mm.
- Suitable for all types of materials, ceramics and natural stone with smooth surfaces.

Benefits

- Suction cup fixing.
- Adjustable knobs for an adjustable size.
- Metal frame.

Benefits

- Perfect centring.
- For mark-free drilling.
- Versatility.



Ref.	Gencod	Qty
440S	3336600202405	1

Ref.
416

Sharpening stone

Sharpening stone 160 x 40 x 20 mm for blue ceram core drill.



Quadropack

TL	Ref.	Gencod	Qty
160	416	3336600146921	1



Ref.
416A

Sharpening stone

Sharpening stone 75 x 35 x 18 mm for blue ceram core drill.



Twistpack

TL	Ref.	Gencod	Qty
70	416A	3336600186156	1



Ref.
417

Sharpening stone

Sharpening stone 60 x 40 x 20 mm for blue ceram core drill.

TL	Ref.	Gencod	Qty
60	417	3336600147331	1



SHARPENING-BRIGHTENING-DIAMOND TOOLS



BLUE ET GREY CERAM



DIAMOND HOLE SAW



DIAMOND CORE BIT

VIDEO TUTO



To avoid overheating, restore cutting power and extend product lifetime:
Regularly sharpen your diamond tools

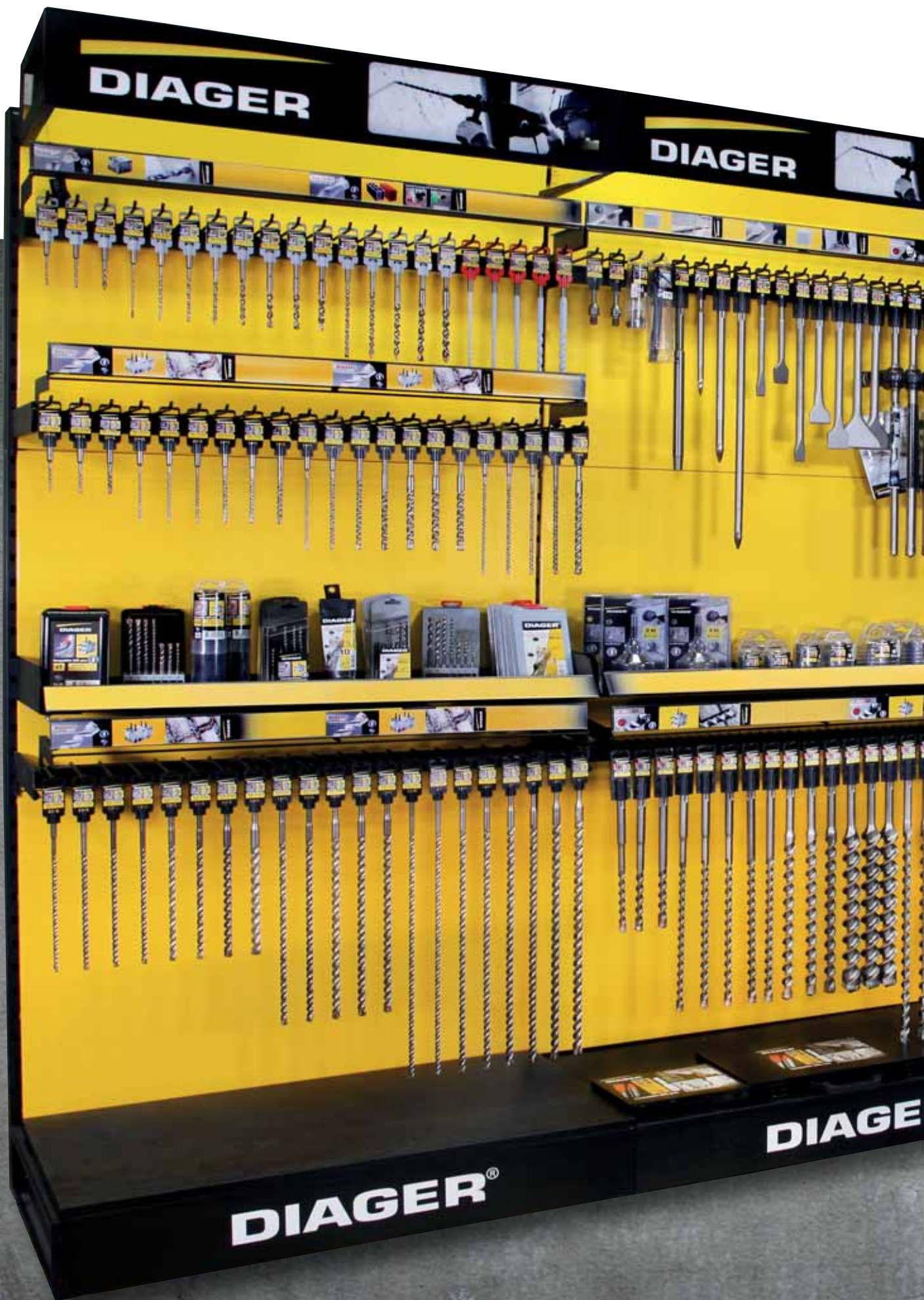

CONCRETE DRILLING



Features	Ref.	Gencod
1M SALES SHELF (to attribute with the pediment of your choice)	GOND1000	3336609000019
NEXT 1M SALES SHELF (to attribute with the pediment of your choice)	GOND1001	3336609000033
LUMINAR PEDIMENT FOR 1M SALES SHELF	M00202	3336609009500
ELECTRIC CABLE FOR LUMINAR PEDIMENT (to attribute with each pediment command)	CORDON	3336600187528
DIAGER PEDIMENT FOR 1M SALES SHELF	FR1000	3336609005472
ADJUSTABLE RACK 1M 20 DOUBLE HOOKS	RAT1000DOUBLE	3336609002211
ADJUSTABLE RACK WITHOUT HOOKS 1M	M00150	3336609004468
DOUBLE HOOK	M00151	3336609004475
SIMPLE HOOK	M00152	3336609004482
ADJUSTABLE SHELF WIDTH 900MM DEPTH 360 MM	M00167	3336609006141

Ref.
263

Optima3+



3 Cutting edges concrete drill bit cylindrical shank

The innovative geometry of the 3 cutting edges carbide tip bit enables precise drilling and increase lifetime.



• 3 CUTTING EDGES TECHNOLOGY

Features

- Monobloc carbide tip.
- Centering tip 130°.
- 3 flutes.

Benefits

- Perfectly round and calibrated hole.
- Lifetime improved due to the 3 contact point.
- Improved strength of fasteners.



Concrete, Granit, Stone, Brick, Breeze block, Hollow brick

Shank



Cylindrical



Quality plastic pouch

Ø	WL	TL	Ref.	Gencod	Qty
Short series					
*3	20	60	263D03	3336600189638	1
*4	35	75	263D04	3336600160415	1
5	45	100	263D05	3336600152991	1
6	60	100	263D06	3336600153004	1
6.5	60	100	263D06.5	3336600153998	1
8	80	120	263D08	3336600153011	1
10	80	120	263D10	3336600153028	1
12	110	150	263D12	3336600153035	1
13	110	150	263D13	3336600154001	1
L150					
5	110	150	263D05L150	3336600189072	1
6	110	150	263D06L150	3336600189089	1
* 2 cutting edges					

Non polished finish

ALL SETS PAGES 114-115

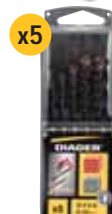

263B

Ref.
226

Mega

Concrete drill bit cylindrical shank

High resistance carbide tip for intensive use.



• INTENSIVE USE

Features

- Semi-positive carbide tip.
- «U» shaped flute.

Benefits

- Fast dust evacuation.
- Intensive use.

Shank



Cylindrical



Concrete, Stone, Brick, Breeze block,
Plaster

ALL
SETS
PAGES 114-115



256C



211C



Ø	WL	TL	Ref.	Gencod	Qty
Short series					
3	20	60	226D03	3336600028296	1
4	35	75	226D04	3336600028302	1
5	45	85	226D05	3336600028319	1
5.5	45	85	226D05.5	3336600028470	1
6	60	100	226D06	3336600028326	1
6.5	60	100	226D06.5	3336600028487	1
7	60	100	226D07	3336600028333	1
8	80	120	226D08	3336600028340	1
9	80	120	226D09	3336600028357	1
10	80	120	226D10	3336600028364	1
11	110	150	226D11	3336600028371	1
12	110	150	226D12	3336600028388	1
13	110	150	226D13	3336600028395	1
14	110	150	226D14	3336600028401	1
15	110	150	226D15	3336600028418	1
16	110	150	226D16	3336600028425	1
18	120	160	226D18	3336600028432	1
20	120	160	226D20	3336600028449	1
22	120	160	226D22	3336600056749	1
L150					
5	110	150	226D05L0150	3336600049062	1
6	110	150	226D06L0150	3336600049079	1
10	110	150	226D10L0150	3336600049116	1
L200					
6	160	200	226D06L0200	3336600062740	1
8	160	200	226D08L0200	3336600049123	1
10	160	200	226D10L0200	3336600049130	1
12	160	200	226D12L0200	3336600049147	1
14	160	200	226D14L0200	3336600049154	1
L400					
6	360	400	226D06L0400	3336600049178	1
8	360	400	226D08L0400	3336600049192	1
10	360	400	226D10L0400	3336600049215	1
12	360	400	226D12L0400	3336600049239	1
14	360	400	226D14L0400	3336600049253	1
16	360	400	226D16L0400	3336600049277	1
20	360	400	226D20L0400	3336600049291	1

Ref.
264

Pro

Concrete drill bit cylindrical shank

High resistance carbide tip for a fast drilling.



FAST DRILLING

Features

- Semi-positive carbide tip.
- Double flute.

Benefits

- Fast drilling speed.



Concrete, Stone, Brick, Breeze block, Plaster

Shank



Cylindrical

Ø	WL	TL	Ref.	Gencod	Qty
Short series					
3	20	60	264D03	3336600056060	1
3.5	35	75	264D03.5	3336600056077	1
4	35	75	264D04	3336600056084	1
5	45	85	264D05	3336600056107	1
5.5	60	100	264D05.5	3336600056114	1
6	60	100	264D06	3336600056121	1
6.5	80	100	264D06.5	3336600056138	1
7	80	100	264D07	3336600056145	1
8	80	120	264D08	3336600056152	1
9	80	120	264D09	3336600056169	1
10	80	120	264D10	3336600056176	1
11	110	150	264D11	3336600056183	1
12	110	150	264D12	3336600056190	1
13	110	150	264D13	3336600056206	1
14	110	150	264D14	3336600056213	1
16	110	150	264D16	3336600056237	1
18	120	160	264D18	3336600056244	1
20	120	160	264D20	3336600056251	1
L150					
5	110	150	264D05L0150	3336600056268	1
6	110	150	264D06L0150	3336600056275	1
7	110	150	264D07L0150	3336600056282	1
8	110	150	264D08L0150	3336600056299	1
10	110	150	264D10L0150	3336600056312	1
L200					
6	160	200	264D06L0200	3336600056329	1
8	160	200	264D08L0200	3336600056343	1
10	160	200	264D10L0200	3336600056350	1
12	160	200	264D12L0200	3336600056367	1



Quality plastic pouch

ALL SETS
PAGES 124-125



208D



201C



299B

Ref.
265

Flash

Concrete drill bit cylindrical shank

FLASH

Specially designed for cordless drills.

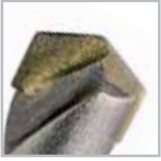

Concrete, Stone, Brick, Breeze block, Plaster

Ø	WL	TL	Ref.	Gencod	Qty
Short series					
3	20	60	265D03	3336600064485	1
3.5	35	75	265D03.5	3336600064492	1
4	35	75	265D04	3336600064508	1
4.5	45	85	265D04.5	3336600064515	1
5	45	85	265D05	3336600064522	1
5.5	55	95	265D05.5	3336600064539	1
6	60	100	265D06	3336600064546	1
6.5	60	100	265D06.5	3336600064553	1
7	60	100	265D07	3336600064560	1
7.5	80	120	265D07.5	3336600064577	1
8	80	120	265D08	3336600064584	1
9	80	120	265D09	3336600064607	1
10	80	120	265D10	3336600064621	1
11	110	150	265D11	3336600064638	1
12	110	150	265D12	3336600064645	1
13	110	150	265D13	3336600064652	1
14	110	150	265D14	3336600064669	1
15	110	150	265D15	3336600064676	1
16	110	150	265D16	3336600064683	1
18	120	160	265D18	3336600064706	1
20	120	160	265D20	3336600064720	1
22	120	160	265D22	3336600064737	1
25	120	160	265D25	3336600064744	1
L150					
5	110	150	265D05L0150	3336600076365	1
5.5	110	150	265D05.5L0150	3336600052666	1
6	110	150	265D06L0150	3336600074958	1
6.5	110	150	265D06.5L0150	3336600052673	1
7	110	150	265D07L0150	3336600074996	1
8	110	150	265D08L0150	3336600075023	1
10	110	150	265D10L0150	3336600075078	1
L200					
6	160	200	265D06L0200	3336600074965	1
7	160	200	265D07L0200	3336600075009	1
8	160	200	265D08L0200	3336600075030	1
10	160	200	265D10L0200	3336600075085	1
12	160	200	265D12L0200	3336600075122	1
14	160	200	265D14L0200	3336600075184	1
16	160	200	265D16L0200	3336600081284	1

Basic grey plastic pouch



• CORDLESS DRILLS

Features

- Carbide tip with refined geometry.

Benefits

- 20% more battery life.
- Higher carbide tip to stay on the axis.

Shank



Cylindrical

Ø	WL	TL	Ref.	Gencod	Qty
L300					
6	260	300	265D06L0300	3336600074972	1
8	260	300	265D08L0300	3336600075047	1
10	260	300	265D10L0300	3336600075092	1
12	260	300	265D12L0300	3336600075139	1
14	260	300	265D14L0300	3336600075191	1
16	260	300	265D16L0300	3336600075221	1
20	260	300	265D20L0300	3336600075269	1
L400					
6	360	400	265D06L0400	3336600074989	1
7	360	400	265D07L0400	3336600084063	1
8	360	400	265D08L0400	3336600075054	1
10	360	400	265D10L0400	3336600075108	1
12	360	400	265D12L0400	3336600075146	1
14	360	400	265D14L0400	3336600075207	1
15	360	400	265D15L0400	3336600082533	1
16	360	400	265D16L0400	3336600075238	1
18	360	400	265D18L0400	3336600075252	1
20	360	400	265D20L0400	3336600075276	1
22	360	400	265D22L0400	3336600075290	1
25	360	400	265D25L0400	3336600075313	1
L600					
6	560	600	265D06L0600	3336600077874	1
8	560	600	265D08L0600	3336600077867	1
10	560	600	265D10L0600	3336600075115	1
12	560	600	265D12L0600	3336600075153	1
14	560	600	265D14L0600	3336600075214	1
16	560	600	265D16L0600	3336600076303	1
18	560	600	265D18L0600	3336600076310	1
20	560	600	265D20L0600	3336600076327	1
22	560	600	265D22L0600	3336600077157	1
L1000					
8	960	1000	265D08L1000	3336600101609	1
10	960	1000	265D10L1000	3336600101616	1
18	960	1000	265D18L1000	3336600101661	1
22	960	1000	265D22L1000	3336600101685	1

ALL SETS
PAGES 124-125



251C



252C



250C

Ref
215

Multi-materials

Multi-materials drill bit cylindrical shank

The sharpened carbide tip enable to drill very hard materials such as high-strength steels (locks, safes), hollow bricks and composite materials. Do not use percussion mode for drilling.

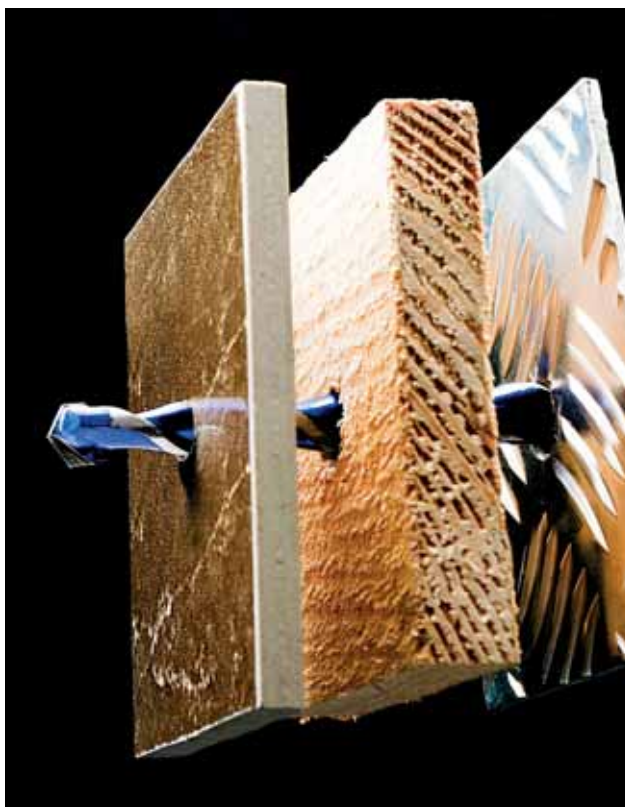

- VERSATILITY
- SPECIAL LOCKSMITH

Features

- Positive carbide tip with centering point.
- Angle tip 118°.
- 4 sided sharpening.

Benefits

- Versatility of use.
- Clean cut.
- Fast penetration.

Applications

- Drilling of composite materials.
- Safe drilling.

Advices

- Do not use the percussion mode.



Low density wood, Alloy steel, Ceramic tile, Slate, Composite, Brick

Shank



Cylindrical

Use



Without percussion



Quality plastic pouch

Ø	WL	TL	Ref.	Gencod	Qty
Short series					
3	20	60	215D03	3336600153813	1
4	35	75	215D04	3336600153820	1
5	45	85	215D05	3336600153837	1
5.5	45	85	215D05.5	3336600153844	1
6	60	100	215D06	3336600153851	1
6.5	60	100	215D06.5	3336600153868	1
7	60	100	215D07	3336600153875	1
8	80	120	215D08	3336600153882	1
9	80	120	215D09	3336600153899	1
10	80	120	215D10	3336600153905	1
12	110	150	215D12	3336600153912	1
13	110	150	215D13	3336600153929	1
14	110	150	215D14	3336600153936	1
16	110	150	215D16	3336600153950	1
L250					
6	210	250	215D06L0250	3336600173286	1
6.5	210	250	215D06.5L0250	3336600173293	1
8	210	250	215D08L0250	3336600173309	1
L300					
10	260	300	215D10L0300	3336600173415	1
12	260	300	215D12L0300	3336600173422	1
13	260	300	215D13L0300	3336600173439	1

ALL SETS
PAGES 126-127

x8



215C

x5



215B

Ref.
245

Ceramik

Ceramik drill bit cylindrical shank



Features

- High strength carbide tip.
- Positive sharpened edges.
- Centering point.

Benefits

- Specially designed for drilling tiles and ceramics.



Ceramic tile

Shank



Cylindrical

Use



Without
percussion



Quality plastic
pouch

Ø	WL	TL	Ref.	Gencod	Qty
3	20	60	245D03	3336600022058	1
4	35	75	245D04	3336600022065	1
5	45	85	245D05	3336600022072	1
6	60	100	245D06	3336600022089	1
6.5	60	100	245D06.5	3336600022713	1
7	80	120	245D07	3336600022720	1
8	80	120	245D08	3336600022096	1
9	80	120	245D09	3336600022737	1
10	80	120	245D10	3336600022102	1
12	110	150	245D12	3336600022744	1



Ref.
208

Granit

Hard stone and granite drill bit cylindrical shank



Features

- High strength carbide tip.

Benefits

- Specially designed for drilling granite and stones.



Granit, Stone, Concrete

Shank



Cylindrical



Non polished
finish



Quality plastic
pouch

Ø	WL	TL	Ref.	Gencod	Qty
3	20	60	208D03	3336600157545	1
4	35	75	208D04	3336600022355	1
5	45	85	208D05	3336600022362	1
5.5	45	85	208D05.5	3336600022379	1
6	60	100	208D06	3336600022386	1
6.5	60	100	208D06.5	3336600022393	1
7	60	100	208D07	3336600022409	1
8	80	120	208D08	3336600022416	1
9	80	120	208D09	3336600022423	1
10	80	120	208D10	3336600022430	1
12	110	150	208D12	3336600022454	1
14	110	150	208D14	3336600022461	1
16	110	150	208D16	3336600022485	1



CERAPRO

TILE DRILL BIT SPECIAL DRILL



LIFETIME



Durability and penetration power, up to 10 times longer than the previous Diager drill version.

PRECISION



Precise priming for easy drilling with no risk of damaging the surface to be drilled.

FAST



Carbide insert with improved cutting edges and ogive profile for greater speed.

ROBUST



Extremely robust carbon steel body with reinforced area between body and shank.

EASY



Non-slip 6-sided shank for optimum fit in the chuck.



CARBIDE DRILL BIT WITH 6-SIDED ATTACHMENT FOR PRECISE DRILLING.

Versatile drill effective in a wide range of materials including ceramics, brick and glass.

Its carbide-tipped, ogive-shaped insert with improved cutting edges and reinforced steel body with anti-slip hexagonal shank ensure long life, ease of use and the guarantee of a clean hole without splintering of the drilled material.

Can be used on a dry drill or with a little water for longer life.

VIDEO DEMO



new

Ref. 413

CeraPro CERAPRO

Tile drill bit with 6-point fitting

Multi-purpose drill effective in a large number of materials such as ceramics, brick or glass.



• IDEAL FOR DRILLING ALL TYPES OF TILES

Description

- Carbide insert with improved cutting edges and pointed profile.
- Extremely robust carbon steel body.
- Anti-slip 6-point fitting.
- Reinforced area between the body and the fitting.

Benefits

- Precision priming for easy drilling without risk of damaging the surface to be drilled.
- Lifespan and penetration power, lasts up to 5 times longer than the previous generation drill bit.
- Extreme resistance to abrasion.
- Drilling the hardest tiles (up to PEI class 5).
- Good hold in the chuck.
- Drilling versatility.

Advices

- To be used with a low rotation speed (see rotation speed table on pages 154-155).
- Can be used dry, however adding a little water will extend the life of the drill bit.
- In the hardest tiles apply sufficient pressure on the drill bit (15 to 20 kg recommended).



Non-tempered glass, Ceramic tile, Plastic, Composite, Brick, Hollow brick

Shank



Hexagonal

Use



without percussion



VIDEO TUTO



DRILLING HARD-TILES



Etui Quality transparent

Ø	WL	TL	Ref.	Gencod	Qt.
3	52	82	413D03	3336600205529	1
4	68	108	413D04	3336600205536	1
5	68	108	413D05	3336600205543	1
6	68	108	413D06	3336600205550	1
7	68	108	413D07	3336600205567	1
8	68	108	413D08	3336600205574	1
9	68	108	413D09	3336600205581	1
10	90	120	413D10	3336600205598	1
12	90	120	413D12	3336600205604	1
13	90	120	413D13	3336600205611	1

TOUS LES SETS PAGES 116-117

x5



4130A

Ref.
400

CERATILE

Glass and tile drill bit cylindrical shank



The sharpened carbide bit enable to drill through hard and delicate materials such as glass, but also plastics and composites.



• DRILL GLASS

Features

- 4 sharpened sides.
- Exclusive designed.
- Copper brazing for a better heat resistance.
- Big length.

Benefits

- Precise and fast penetration.
- Drilling ceramics up to class 3.
- Resistance to heating.

Advices

- Easy dry operation, see table of recommended speeds on our website.



Non-tempered glass, Ceramic tile, Plastic, Composite, Brick, Hollow brick, Marble

Shank



Cylindrical

Use



Without percussion



Quality plastic pouch

Ø	WL	TL	Ref.	Gencod	Qty
3	40	80	400D03	3336600014466	1
4	40	80	400D04	3336600014473	1
5	40	80	400D05	3336600014480	1
6	40	80	400D06	3336600014497	1
7	60	100	400D07	3336600014503	1
8	60	100	400D08	3336600014510	1
9	60	100	400D09	3336600014527	1
10	60	100	400D10	3336600014534	1
12	60	100	400D12	3336600014541	1
13	60	100	400D13	3336600093546	1

ALL SETS
PAGES 126-127



VIDEO DEMO



LENGTH

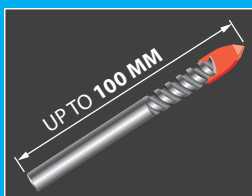

FAST SPIRAL

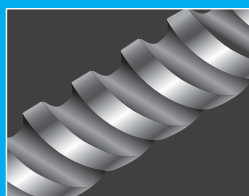

CARBIDE TIP

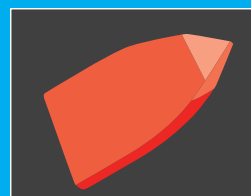

Ref.
201

HPL



Composite drill bit cylindrical shank

Special drill bit for external and internal cladding panels, furniture and decoration surfacing products.



• LONG LIFE

Features

- Carbide tip with 2 tracers.
- Crown sharpening.
- Centering tip cut at 75°.
- Glossy polished finish.

Benefits

- Clean hole without chip.
- Self centering point for easy starts.
- Long service life.
- Fast penetration.

Applications

• For the drilling of interior panels such as Corian®, wood, composite materials, plastic, or facade panels such as fibre cement, HPL, ...

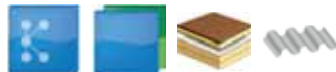

Composite, Plastic, HPL, Cement fibre

Shank



Cylindrical

Use



Without percussion



Quality plastic pouch

Ø	WL	TL	Ref.	Gencod	Qty
5	45	85	201D05	3336600174948	1
6	60	100	201D06	3336600174955	1
8	80	120	201D08	3336600174962	1
9	80	120	201D09	3336600202665	1



Ref.
781

HSS - Hexagonal

Metal drill bit quick lock shank



Features

- Monobloc drill bit.
- Point angle 135°.
- Split point.



Alloy steel, Non-alloy steel, Cast iron, Brass,
Hard wood, Composite

Shank

Drill &
screwdriver



Quick Lock
1/4" - 6.35



Ø	WL	TL	Ref.	Gencod	Qty
3	26	60	781D03	3336600166813	1
3.3	26	60	781D03.3	3336600166820	1
3.5	30	65	781D03.5	3336600166837	1
4	30	65	781D04	3336600166844	1
4.2	30	65	781D04.2	3336600166851	1
4.5	30	65	781D04.5	3336600166868	1
5	34	68	781D05	3336600166875	1
6	34	70	781D06	3336600166882	1
8	38	79	781D08	3336600166905	1

Ref.
981

WOOD - Hexagonal

Wood drill bit quick lock shank



Features

- Monobloc drill bit.
- 3 points.



Hard wood, Low density wood

Shank

Drill &
screwdriver



Quick Lock
1/4" - 6.35



Ø	WL	TL	Ref.	Gencod	Qty
3	35	65	981D03	3336600166936	1
4	40	75	981D04	3336600166943	1
5	50	85	981D05	3336600166950	1
6	55	90	981D06	3336600166967	1
7	55	90	981D07	3336600166929	1
8	55	90	981D08	3336600166974	1
10	60	100	981D10	3336600166981	1

Ref.
403

Tracing point

Features

- Scribing iron with hex-shank 6 mm.

Applications

- For an accurate tracing on sheet-metal plat.



Quality plastic pouch

Ø	Ref.	Gencod	Qty
6	403	3336600016477	1

Ref.
407

Carbide claw

Features

- The tool is fitted with a carbide cutting point.
- Wooden handle.

Advices

- Using a rule, scratch the surface of the material with the tool and break it there.



Black plastic pouch

Ref.	Gencod	Qty
407	3336600002326	1

Ref.
300

Driving bolt SDS-plus compatible

Driving an earth rod for electrical installation.

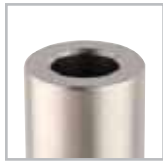

Tube Srewpack

Ø	TL	Ref.	Gencod	Qt.
20	260	300W20L0260	3336600208896	1

Ref.
301

Driving bolt SDS-max compatible

Driving an earth rod for electrical installation.



Tube Srewpack

Ø	TL	Ref.	Gencod	Qt.
35	260	301W35L0260	3336600208902	1



A man with a focused expression is inspecting a silver, double-flute drill bit with a red handle. He is holding the bit up to his eye, examining its sharp edges. The background is dark, and the lighting highlights the metallic texture of the drill bit and the man's features. In the foreground, a large number of similar drill bits are arranged in rows, creating a sense of mass production. The Diager logo is visible in the bottom right corner.

MORE THAN 150 000 FORESTS CONTROLLED EACH

How can we guarantee perfect quality without supporting each stage of production and without carrying out continuous product controls? These are the qualitative procedures that mark the journey of a tool within the workshops, guaranteeing their compliance throughout the year. Diager is entering a market where quality standards are a priority.

DIAGER®

CONCRETE

BOOSTER-PLUS

x10



072B

x5



104B

x5



115C

x7



113D

4G4

x5



112Q

x10

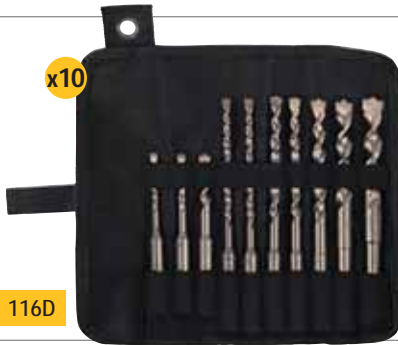

116D

TWISTER-PLUS

x4



100C

x5



136C

x7



102C

x7



105D

Features

Pcs

Type

Composition

Ref.

Gencod

BOOSTER PLUS	5	Set	L110 mm Ø6-8 L160 mm Ø6-8-10 mm	104B	3336600075658
BOOSTER PLUS	5	Set	L110 mm Ø5(x2) L160 mm Ø6 (x2)-8 mm	115C	3336600141278
BOOSTER PLUS	7	Metal set	L110 mm Ø6-8-10 L160 mm Ø6-8-10-12 mm	113D	3336600060876
BOOSTER PLUS	10	Pouch	L160 mm Ø6(x3)-8(x3)-10(x2)-12-14 mm	072B	3336600104082
4G4 DRILL BIT	5	Set	L160 mm Ø6-8(x2)-10-12 mm	112Q	3336600197046
TWISTER PLUS	4	Set	L160 mm Ø5-6-8-10 mm	100C	3336600064881
TWISTER PLUS	5	Set	L110 mm Ø6-8 L160 mm Ø6-8-10 mm	136C	3336600054202
TWISTER PLUS	7	Set	L110 mm Ø5-6-8 L160 mm Ø6-8-10-12 mm	102C	3336600064904
TWISTER PLUS	7	Metal set	L110 mm Ø5-6-8 L160 mm Ø6-8-10-12 mm	105D	3336600007369
TWISTER PLUS	10	Pouch	L110 mm Ø5-6-8 L160 mm Ø6(x2)-8(x2)-10-12-14 mm	116D	3336600007406



252C



251C



250C



263B



211C



256C



201C



299B

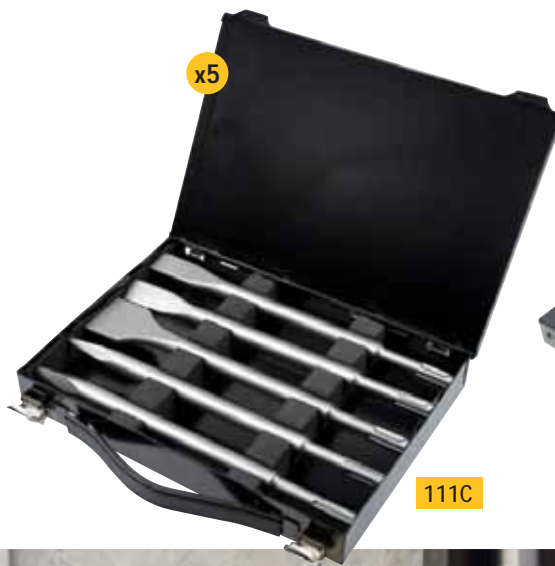

111C

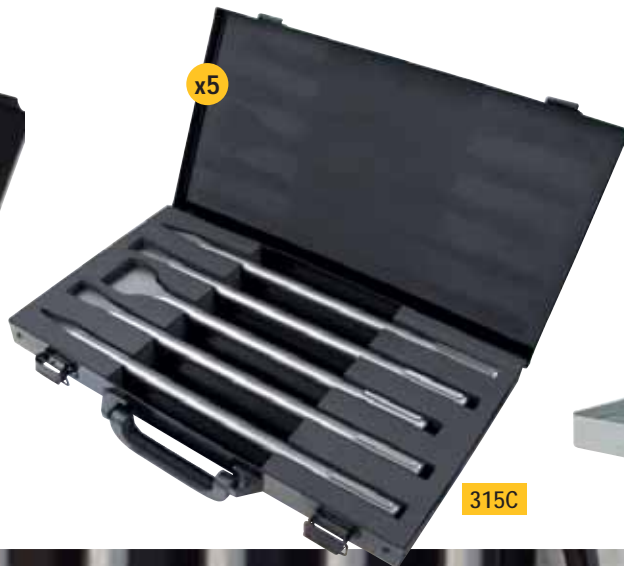

315C



208D

Features	Pcs	Type	Composition	Ref.	Gencod
FLASH	5	Set	FLASH Ø4-5-6-7-8 mm	252C	3336600006911
FLASH	5	Set	FLASH Ø4-5-6-8-10 mm	251C	3336600006904
FLASH	8	Set	FLASH Ø3-4-5-6-7-8-9-10 mm	250C	3336600006898
OPTIMA3+	5	Solo	OPTIMA-3 Ø4-5-6-8-10 mm	263B	3336600160484
MEGA	5	Solo	MEGA Ø4-5-6-8-10 mm	211C	3336600064973
MEGA	8	Solo	MEGA Ø3-4-5-6-7-8-9-10 mm	256C	3336600083578
PRO	5	Solo	PRO Ø4-5-6-8-10 mm	201C	3336600006935
PRO	8	Duo	PRO Ø3-4-5-6-7-8-9-10 mm	299B	3336600107670
PRO	7	Metal set	PRO Ø4-5-6-7-8-10-12 mm	208D	3336600007444
SDS+ POINTED AND CHISELS	5	Case	SDS-Plus pointed chisel 14x250(x2) flat chisel 20x250(x2) 40x250 mm	111C	3336600167469
SDS MAX POINTED AND CHISELS	5	Case	SDS-Max pointed chisel 18x400(x2) flat chisel 24x400(x2) 50x360 mm	315C	3336600180635



SPECIFIC



207B



214B



239B



215B



215C



431C

Features	Pcs	Type	Composition	Ref.	Gencod
GRANIT	8	Duo	GRANIT Ø3-4-5-6-7-8-9-10 mm	207B	3336600075665
CERAMIK	5	Solo	CERAMIK Ø4-5-6-8-10 mm	214B	3336600107687
CERAMIK	8	Duo	CERAMIK Ø3-4-5-6-7-8-9-10 mm	239B	3336600075672
MULTI-MATERIALS	5	Solo	MULTI-MATERIALS Ø4-5-6-8-10 mm	215B	3336600166790
MULTI-MATERIALS	8	Set	MULTI-MATERIALS Ø3-4-5-6-7-8-9-10 mm	215C	3336600166783
DIAMOND CORE BIT	4	Kit	Diamond core bit Ø68 + SDS-Plus core bit holder L100 + centring guide + sharpening stone	431C	3336600162662





x5

408C



x6

426C



x9

426B

Features	Pcs	Type	Composition	Ref.	Gencod
CERATILE	5	Pouch	CERATILE Ø6 (X3)-Ø8(X2) mm	408C	3336600178601
BLUE CERAM	6	Pouch	BLUE-CERAM 6pcs Ø6(x2)-8(x2) mm chuck & sharpening stone	426C	3336600151901
BLUE CERAM	9	Pouch	BLUE-CERAM Ø6 (x2)-8 (x2)-10-15-20 mm chuck & sharpening stone	426B	3336600160224



Ref.
731

Cobalt 5%

Fully ground HSS drill bit 5% cobalt HSS-E

The addition of cobalt in the composition of the steel provides better resistance to heating and increases resistance enable drilling stainless steel and alloyed steels (up to 1200N/mm²).



• HEAT-RESISTANT

Features

- Fully ground 5% cobalt.
- Split point 135°.
- DIN 338.
- N type flute.
- Diameter tolerance h8.

Benefits

- Drilling in stainless steel.
- High temperature resistance.
- Accuracy when starting drilling.



Stainless steel, Alloy steel, Non-alloy steel,
Cast iron, Cast iron, Spheroidal

Shank



Cylindrical

Angle



Sharpening



Ø	WL	TL	Ref.	Gencod	Qty
Plastic pouch of 1 Piece					
2	24	49	731D02	3336600021563	1
2.5	30	57	731D02.5	3336600021570	1
3	33	61	731D03	3336600021587	1
3.2	36	65	731D03.2	3336600021600	1
3.5	39	70	731D03.5	3336600021631	1
4	43	75	731D04	3336600021662	1
4.2	43	75	731D04.2	3336600021686	1
4.5	47	80	731D04.5	3336600021716	1
5	52	86	731D05	3336600021761	1
5.2	52	86	731D05.2	3336600021785	1
5.5	57	93	731D05.5	3336600021815	1
6	57	93	731D06	3336600021846	1
6.2	63	101	731D06.2	3336600021853	1
6.5	69	109	731D06.5	3336600021860	1
7	69	109	731D07	3336600021884	1
7.5	75	117	731D07.5	3336600021891	1
8	75	117	731D08	3336600021907	1
8.5	81	125	731D08.5	3336600021921	1
9	81	125	731D09	3336600021938	1
9.5	81	125	731D09.5	3336600021952	1
10	87	133	731D10	3336600021969	1
10.5	87	133	731D10.5	3336600021976	1
11	94	142	731D11	3336600021983	1
11.5	94	142	731D11.5	3336600021990	1
12	101	151	731D12	3336600022003	1
12.5	101	151	731D12.5	3336600022010	1
13	101	151	731D13	3336600022027	1



Quality plastic pouch

Ref.
700

Fully ground HSS drill bit 5% cobalt HSS-E pack 5 or 10

The addition of cobalt in the composition of the steel provides better resistance to heating and increases resistance enable drilling stainless steel and alloyed steels (up to 1200N/mm²).



Ø	WL	TL	Ref.	Gencod	Qty
Quadropack of 10 Pieces					
2	24	49	700D02	3336600016644	1
2.5	30	57	700D02.5	3336600016651	1
3	33	61	700D03	3336600016668	1
3.2	36	65	700D03.2	3336600016682	1
3.3	36	65	700D03.3	3336600016699	1
3.5	39	70	700D03.5	3336600016712	1
4	43	75	700D04	3336600016743	1
4.2	43	75	700D04.2	3336600016767	1
4.5	47	80	700D04.5	3336600016798	1
4.8	52	86	700D04.8	3336600016828	1
5	52	86	700D05	3336600016842	1
5.2	52	86	700D05.2	3336600016866	1
5.5	57	93	700D05.5	3336600016897	1
6	57	93	700D06	3336600016927	1
6.2	63	101	700D06.2	3336600016934	1
6.5	63	101	700D06.5	3336600016941	1
6.8	69	109	700D06.8	33366000167285	1
7	69	109	700D07	3336600016965	1
7.5	75	117	700D07.5	3336600016972	1
8	75	117	700D08	3336600016989	1
8.5	81	125	700D08.5	3336600016996	1
9	81	125	700D09	3336600017009	1
9.5	81	125	700D09.5	3336600017023	1
10	87	133	700D10	3336600017030	1
Quadropack of 5 Pieces					
10.5	87	133	700D10.5	3336600017047	1
11	94	142	700D11	3336600017054	1
11.5	94	142	700D11.5	3336600017061	1
12	101	151	700D12	3336600017078	1
12.5	101	151	700D12.5	3336600017085	1
13	101	151	700D13	3336600017092	1



Quadropack

ALL
SETS
PAGES 150-151



x19

708D



x25

707D



x6

706C



x10

720C



Ref.
702

Multi-layers coating G3 **HSS-G 3**

Fully ground HSS drill bit TiAlN coating

HSS G3 drill bit has a TiAlN coating that acts as a thermal barrier and reduce friction to facilitate chip evacuation. Drilling non-alloy and alloy steels (up to 1100N/mm²), cast iron, aluminium.

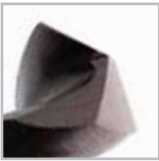

• HIGH CUTTING SPEED

Features

- Multi-layers TiAlN coating.
- Fully ground HSS drill bit.
- Split point 135°.
- DIN 338 - S type flute.
- Diameter tolerance h8.

Benefits

- Priming accuracy at start-up.
- Multiple coating acts as a thermal barrier against heating and allows a longer lifetime.
- The coating reduce friction, facilitate dust removal and increases cutting speed.

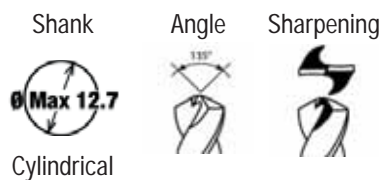

Alloy steel, Non-alloy steel,
Cast iron, Cast iron, Spheroidal



DIY tube

Ø	WL	TL	Ref.	Gencod	Qty
Plastic tube of 2 pieces					
1	12	34	702D01	3336600154773	1
1.5	18	40	702D01.5	3336600154780	1
2	24	49	702D02	3336600154797	1
2.5	30	57	702D02.5	3336600154803	1
3	36	65	702D03	3336600154810	1
3.2	36	65	702D03.2	3336600154827	1
3.3	36	65	702D03.3	3336600157828	1
3.5	39	70	702D03.5	3336600154834	1
4	43	75	702D04	3336600154841	1
4.2	43	75	702D04.2	3336600154858	1
4.5	47	80	702D04.5	3336600154865	1
4.8	52	86	702D04.8	3336600154872	1
5	52	86	702D05	3336600154889	1
Plastic tube of 1 piece					
5.5	57	93	702D05.5	3336600154902	1
6	57	93	702D06	3336600154919	1
6.5	63	101	702D06.5	3336600154933	1
6.8	69	109	702D06.8	3336600154940	1
7	69	109	702D07	3336600154957	1
7.5	69	109	702D07.5	3336600154964	1
8	75	117	702D08	3336600154971	1
8.5	75	117	702D08.5	3336600154988	1
9	81	125	702D09	3336600154995	1
9.5	81	125	702D09.5	3336600155008	1
10	87	133	702D10	3336600155015	1
10.2	87	133	702D10.2	3336600157835	1
10.5	87	133	702D10.5	3336600155022	1
11	94	142	702D11	3336600155039	1
11.5	94	142	702D11.5	3336600155046	1
12	101	151	702D12	3336600155053	1
12.5	101	151	702D12.5	3336600155060	1
13	101	151	702D13	3336600155077	1
14	108	160	702D14	3336600164529	1
15	114	169	702D15	3336600164536	1
16	120	178	702D16	3336600164543	1
17	125	184	702D17	3336600179073	1
18	130	191	702D18	3336600179080	1
19	135	198	702D19	3336600179097	1
20	140	205	702D20	3336600179103	1

Ref.
703

Fully ground HSS drill bit TiAlN coating pack 2, 5 or 10

HSS G3 drill bit has a TiAlN coating that acts as a thermal barrier and reduce friction to facilitate chip evacuation. Drilling non-alloy and alloy steels (up to 1100N/mm²), cast iron, aluminium.



Ø	WL	TL	Ref.	Gencod	Qty
Quadropack of 10 pieces					
1	12	34	703D01	3336600157903	1
1.2	16	38	703D01.2	3336600177024	1
1.4	18	40	703D01.4	3336600177048	1
1.5	18	40	703D01.5	3336600157910	1
1.6	20	43	703D01.6	3336600177055	1
1.8	22	46	703D01.8	3336600177062	1
2	24	49	703D02	3336600157927	1
2.3	27	53	703D02.3	3336600177079	1
2.4	30	57	703D02.4	3336600177086	1
2.5	30	57	703D02.5	3336600157934	1
2.6	30	57	703D02.6	3336600177093	1
2.7	30	61	703D02.7	3336600177109	1
2.9	30	61	703D02.9	3336600177116	1
3	36	65	703D03	3336600157941	1
3.1	36	65	703D03.1	3336600177123	1
3.2	36	65	703D03.2	3336600157958	1
3.3	36	65	703D03.3	3336600157965	1
3.4	39	70	703D03.4	3336600177130	1
3.5	39	70	703D03.5	3336600157972	1
3.6	39	70	703D03.6	3336600177147	1
3.7	39	70	703D03.7	3336600177154	1
3.8	43	75	703D03.8	3336600177161	1
4	43	75	703D04	3336600157989	1
4.1	43	75	703D04.1	3336600177178	1
4.2	43	75	703D04.2	3336600157996	1
4.3	47	80	703D04.3	3336600177185	1
4.5	47	80	703D04.5	3336600158009	1
4.6	47	80	703D04.6	3336600177192	1
4.7	47	80	703D04.7	3336600177208	1
4.8	52	86	703D04.8	3336600158016	1
4.9	52	86	703D04.9	3336600177215	1
5	52	86	703D05	3336600158023	1
5.1	52	86	703D05.1	3336600177222	1
5.2	52	86	703D05.2	3336600158030	1
5.3	52	86	703D05.3	3336600177239	1

Ø	WL	TL	Ref.	Gencod	Qty
5.5	57	93	703D05.5	3336600158047	1
5.8	57	93	703D05.8	3336600177246	1
6	57	93	703D06	3336600158054	1
6.2	63	101	703D06.2	3336600158061	1
6.5	63	101	703D06.5	3336600158078	1
6.8	69	109	703D06.8	3336600158085	1
7	69	109	703D07	3336600158092	1
7.3	69	109	703D07.3	3336600177277	1
7.4	69	109	703D07.4	3336600177284	1
7.5	69	109	703D07.5	3336600158108	1
8	75	117	703D08	3336600158115	1
8.5	75	117	703D08.5	3336600158122	1
9	81	125	703D09	3336600158139	1
9.5	81	125	703D09.5	3336600158146	1
10	87	133	703D10	3336600158153	1
Quadropack of 5 pieces					
10.2	87	133	703D10.2	3336600177314	1
10.5	87	133	703D10.5	3336600158160	1
11	94	142	703D11	3336600158177	1
11.5	94	142	703D11.5	3336600158184	1
12	101	152	703D12	3336600158191	1
12.5	101	152	703D12.5	3336600158207	1
13	101	151	703D13	3336600158214	1
Quadropack of 2 pieces					
14	108	160	703D14	3336600177321	1
15	114	169	703D15	3336600177338	1
15.5	120	178	703D15.5	3336600181120	1
16	120	178	703D16	3336600177345	1



ALL SETS
PAGES 150-151



Ref.
729

HSS PRO

Fully ground HSS drill bit

Multi-purpose HSS drill bit for general use. Drills through unalloyed and alloyed steels up to 900N/mm².



Alloy steel, Non-alloy steel,
Cast iron, Cast iron, Spheroidal



• VERSATILITY

Features

- Fully ground HSS drill bit.
- Split point 118°.
- DIN 338 - N type flute.
- Diameter tolerance h8.

Benefits

- Priming accuracy at start-up.
- Fast drilling.

Shank



Cylindrical

Angle



Sharpening



Ø	WL	TL	Ref.	Gencod	Qty
Plastic pouch of 2 Pieces					
1	12	34	729D01	3336600007734	1
1.5	18	40	729D01.5	3336600007741	1
2	24	49	729D02	3336600007758	1
2.5	30	57	729D02.5	3336600007765	1
3	33	61	729D03	3336600007772	1
3.2	36	65	729D03.2	3336600007789	1
3.3	36	65	729D03.3	3336600012325	1
3.5	39	70	729D03.5	3336600007796	1
4	43	75	729D04	3336600007802	1
4.2	43	75	729D04.2	3336600007819	1
4.3	47	80	729D04.3	3336600012356	1
4.5	47	80	729D04.5	3336600007826	1
5	52	86	729D05	3336600007833	1
Plastic pouch of 1 Piece					
5.2	52	86	729D05.2	3336600007840	1
5.5	57	93	729D05.5	3336600007857	1
6	57	93	729D06	3336600007864	1
6.2	63	101	729D06.2	3336600012370	1
6.5	63	101	729D06.5	3336600007871	1
7	69	109	729D07	3336600007888	1
7.5	69	109	729D07.5	3336600007895	1
8	75	117	729D08	3336600007901	1
8.5	75	117	729D08.5	3336600007918	1
9	81	125	729D09	3336600007925	1
9.5	81	125	729D09.5	3336600007932	1
10	87	133	729D10	3336600007949	1
10.5	87	133	729D10.5	3336600007956	1
11	94	142	729D11	3336600007963	1
11.5	94	142	729D11.5	3336600007970	1
12	101	151	729D12	3336600007987	1
12.5	101	151	729D12.5	3336600007994	1
13	101	151	729D13	3336600008007	1
13.5	108	160	729D13.5	3336600009547	1
14	108	160	729D14	3336600009554	1
14.5	114	169	729D14.5	3336600009561	1
15	114	169	729D15	3336600009578	1
15.5	120	178	729D15.5	3336600009585	1
16	120	178	729D16	3336600009592	1
16.5	125	184	729D16.5	3336600009608	1
17	125	184	729D17	3336600009615	1
18	130	191	729D18	3336600009639	1
19	135	198	729D19	3336600009653	1
20	140	205	729D20	3336600009677	1



Quality plastic pouch

Ref.
726

Fully ground HSS drill bit pack 2, 5 or 10

Multi-purpose HSS drill bit for general use. Drills through unalloyed and alloyed steels up to 900N/mm².



Ø	WL	TL	Ref.	Gencod	Qty	Ø	WL	TL	Ref.	Gencod	Qty	
Quadpack of 10 Pieces												
0.8	10	30	726D0.8	3336600022034	1	6.6	63	101	726D06.6	3336600010970	1	
1	12	34	726D01	3336600010413	1	6.7	63	101	726D06.7	3336600010987	1	
1.1	14	36	726D01.1	3336600010420	1	6.8	69	109	726D06.8	3336600010994	1	
1.2	16	38	726D01.2	3336600010437	1	6.9	69	109	726D06.9	3336600011007	1	
1.3	16	38	726D01.3	3336600010444	1	7	69	109	726D07	3336600011014	1	
1.4	18	40	726D01.4	3336600010451	1	7.1	69	109	726D07.1	3336600011021	1	
1.5	18	40	726D01.5	3336600010468	1	7.2	69	109	726D07.2	3336600011038	1	
1.6	20	43	726D01.6	3336600010475	1	7.3	69	109	726D07.3	3336600011045	1	
1.7	20	43	726D01.7	3336600010482	1	7.4	69	109	726D07.4	3336600011052	1	
1.8	22	46	726D01.8	3336600010499	1	7.5	69	109	726D07.5	3336600011069	1	
1.9	22	46	726D01.9	3336600010505	1	7.6	75	117	726D07.6	3336600011076	1	
2	24	49	726D02	3336600010512	1	7.7	75	117	726D07.7	3336600011151	1	
2.1	24	49	726D02.1	3336600010529	1	7.8	75	117	726D07.8	3336600011168	1	
2.2	27	53	726D02.2	3336600010536	1	7.9	75	117	726D07.9	3336600011175	1	
2.3	27	53	726D02.3	3336600010543	1	8	75	117	726D08	3336600011182	1	
2.4	30	57	726D02.4	3336600010550	1	8.1	75	117	726D08.1	3336600011199	1	
2.5	30	57	726D02.5	3336600010567	1	8.2	75	117	726D08.2	3336600011205	1	
2.6	30	57	726D02.6	3336600010574	1	8.3	75	117	726D08.3	3336600011212	1	
2.7	33	61	726D02.7	3336600010581	1	8.4	75	117	726D08.4	3336600011229	1	
2.8	33	61	726D02.8	3336600010598	1	8.5	75	117	726D08.5	3336600011236	1	
2.9	33	61	726D02.9	3336600010604	1	8.6	81	125	726D08.6	3336600011243	1	
3	33	61	726D03	3336600010611	1	8.7	81	125	726D08.7	3336600011250	1	
3.1	36	65	726D03.1	3336600010628	1	8.8	81	125	726D08.8	3336600011267	1	
3.2	36	65	726D03.2	3336600010635	1	8.9	81	125	726D08.9	3336600011274	1	
3.3	36	65	726D03.3	3336600010642	1	9	81	125	726D09	3336600011281	1	
3.4	39	70	726D03.4	3336600010659	1	9.1	81	125	726D09.1	3336600011298	1	
3.5	39	70	726D03.5	3336600010666	1	9.2	81	125	726D09.2	3336600011304	1	
3.6	39	70	726D03.6	3336600010673	1	9.3	81	125	726D09.3	3336600011311	1	
3.7	39	70	726D03.7	3336600010680	1	9.4	81	125	726D09.4	3336600011328	1	
3.8	43	75	726D03.8	3336600010697	1	9.5	81	125	726D09.5	3336600011335	1	
3.9	43	75	726D03.9	3336600010703	1	9.6	87	133	726D09.6	3336600011342	1	
4	43	75	726D04	3336600010710	1	9.7	87	133	726D09.7	3336600011359	1	
4.1	43	75	726D04.1	3336600010727	1	9.8	87	133	726D09.8	3336600011366	1	
4.2	43	75	726D04.2	3336600010734	1	9.9	87	133	726D09.9	3336600011373	1	
4.3	47	80	726D04.3	3336600010741	1	10	87	133	726D10	3336600011380	1	
4.4	47	80	726D04.4	3336600010758	1	Quadpack of 5 Pieces						
4.5	47	80	726D04.5	3336600010765	1	10.5	87	133	726D10.5	3336600011397	1	
4.6	47	80	726D04.6	3336600010772	1	11	94	142	726D11	3336600011403	1	
4.7	47	80	726D04.7	3336600010789	1	11.5	94	142	726D11.5	3336600011410	1	
4.8	52	86	726D04.8	3336600010796	1	12	101	151	726D12	3336600011427	1	
4.9	52	86	726D04.9	3336600010802	1	12.5	101	151	726D12.5	3336600011434	1	
5	52	86	726D05	3336600010819	1	13	101	151	726D13	3336600011441	1	
5.1	52	86	726D05.1	3336600010826	1	13.5	108	160	726D13.5	3336600011458	1	
5.2	52	86	726D05.2	3336600010833	1	Quadpack of 2 Pieces						
5.3	52	86	726D05.3	3336600010840	1	14	108	160	726D14	3336600011465	1	
5.4	57	93	726D05.4	3336600010857	1	14.5	114	169	726D14.5	3336600011472	1	
5.5	57	93	726D05.5	3336600010864	1	15	114	169	726D15	3336600011489	1	
5.6	57	93	726D05.6	3336600010871	1	15.5	120	178	726D15.5	3336600011496	1	
5.7	57	93	726D05.7	3336600010888	1	16	120	178	726D16	3336600011502	1	
5.8	57	93	726D05.8	3336600010895	1	16.5	125	184	726D16.5	3336600011519	1	
5.9	57	93	726D05.9	3336600010901	1	17	125	184	726D17	3336600011526	1	
6	57	93	726D06	3336600010918	1	17.5	130	191	726D17.5	3336600011533	1	
6.1	63	101	726D06.1	3336600010925	1	18	130	191	726D18	3336600011540	1	
6.2	63	101	726D06.2	3336600010932	1	18.5	135	198	726D18.5	3336600011557	1	
6.3	63	101	726D06.3	3336600010949	1	19	135	198	726D19	3336600011564	1	
6.4	63	101	726D06.4	3336600010956	1	19.5	140	205	726D19.5	3336600011571	1	
6.5	63	101	726D06.5	3336600010963	1	20	140	205	726D20	3336600011588	1	



ALL SETS
PAGES 150-151



Ref.
735

HSS PRO long series

Fully ground HSS drill bit long series

Multi-purpose HSS drill bit long series for general use. Drills through unalloyed and alloyed steels up to 900N/mm².



• VERSATILITY

Features

- Fully ground HSS drill bit.
- Split point 118°.
- DIN 340 - N type flute.
- Diameter tolerance h8.

Benefits

- Priming accuracy at start-up.
- Fast drilling.



Alloy steel, Non-alloy steel, Cast iron,
Cast iron, Spheroidal

Shank



Cylindrical

Angle



Ø	WL	TL	Ref.	Gencod	Qty
Plastic pouch of 1 Piece					
2	56	85	735D02	3336600012455	1
3	66	100	735D03	3336600011922	1
4	78	119	735D04	3336600011939	1
5	87	132	735D05	3336600011946	1
6	91	139	735D06	3336600011953	1
7	102	159	735D07	3336600012462	1
8	109	165	735D08	3336600011960	1
9	115	175	735D09	3336600012479	1
10	121	184	735D10	3336600011977	1
11	128	195	735D11	3336600012486	1
12	134	205	735D12	3336600012493	1
13	134	205	735D13	3336600012509	1



Quality plastic pouch

Ref.
713

Fully ground HSS drill bit long series pack 5 or 10

Multi-purpose HSS drill bit long series for general use. Drills through unalloyed and alloyed steels up to 900N/mm².



Ø	WL	TL	Ref.	Gencod	Qty
Quadropack of 10 Pieces					
2	56	85	713D02	3336600018464	1
2.5	62	95	713D02.5	3336600018518	1
3	66	100	713D03	3336600018563	1
3.2	69	106	713D03.2	3336600018587	1
3.5	73	112	713D03.5	3336600018617	1
4	78	119	713D04	3336600018662	1
4.2	78	119	713D04.2	3336600018686	1
4.5	82	126	713D04.5	3336600018716	1
5	87	132	713D05	3336600018761	1
5.2	87	132	713D05.2	3336600018785	1
5.5	91	139	713D05.5	3336600018815	1
5.8	91	139	713D05.8	3336600018846	1
6	91	139	713D06	3336600018860	1
6.2	97	148	713D06.2	3336600018884	1
6.5	97	148	713D06.5	3336600018914	1
7	102	156	713D07	3336600018969	1
7.5	102	156	713D07.5	3336600019027	1
8	109	165	713D08	3336600019072	1
8.5	109	165	713D08.5	3336600019126	1
9	115	175	713D09	3336600019171	1
9.5	115	175	713D09.5	3336600019225	1
10	121	184	713D10	3336600019270	1
Quadropack of 5 Pieces					
11	128	195	713D11	3336600019294	1
12	134	205	713D12	3336600019317	1
13	134	205	713D13	3336600019331	1



Quadropack



Ref.
712

Fully ground HSS drill bit extra short series pack 10

Multi-purpose HSS drill bit extra short series for general use. Drills through unalloyed and alloyed steels up to 900N/mm².



Ø	WL	TL	Ref.	Gencod	Qty
Quadropack of 10 Pieces					
2	12	38	712D02	3336600017948	1
2.5	14	43	712D02.5	3336600017993	1
3	16	46	712D03	3336600018051	1
3.2	18	49	712D03.2	3336600018075	1
3.3	18	49	712D03.3	33366000164710	1
3.5	20	52	712D03.5	3336600018105	1
4	22	55	712D04	3336600018150	1
4.2	22	55	712D04.2	3336600018174	1
4.5	24	58	712D04.5	3336600018204	1
5	26	62	712D05	3336600018228	1
5.2	26	62	712D05.2	3336600018242	1
5.5	28	66	712D05.5	3336600018259	1
6	28	66	712D06	3336600018273	1
6.2	31	70	712D06.2	3336600018280	1
6.5	31	70	712D06.5	3336600018297	1
7	34	74	712D07	3336600018310	1
7.5	34	74	712D07.5	3336600018334	1
8	37	79	712D08	3336600018358	1



Quadropack



Ref.
715

Fully ground HSS drill bit double point pack 10

Multi purpose HSS drill bit double point for general use.



Ø	WL	TL	Ref.	Gencod	Qty
Quadropack of 10 Pieces					
3.1	12	49	715D03.1	3336600017849	1
3.2	12	49	715D03.2	3336600017856	1
3.3	12	49	715D03.3	3336600017863	1
3.5	13	52	715D03.5	3336600017870	1
4	14	55	715D04	3336600017887	1
4.1	14	55	715D04.1	3336600017894	1
4.2	14	55	715D04.2	3336600017900	1
5	17	62	715D05	3336600017917	1
5.1	17	62	715D05.1	3336600017924	1
5.2	17	62	715D05.2	3336600017931	1



Quadropack



Ref.
750

Standard HSS roll forged drill bit

HSS drill bit for general use pack 2, 5 or 10 units.



• DRILL BIT ELASTICITY

Features

- Roll forged HSS drill bit.
- Point angle 118°.
- DIN 338 - N type flute.
- Diameter tolerance h8.

Benefits

- Rolling process gives elasticity and reduce the risk of breaking.

Applications

- Drilling of unalloyed and alloyed steels up to 900nm², cast iron, PVC.



Alloy steel, Non-alloy steel, Cast iron, Cast iron, Spheroidal

Shank



Cylindrical

Angle



Sharpening



Quadrapack

Ø	WL	TL	Ref.	Gencod	Qty
Quadrapack of 10 pieces					
2	24	49	750D02	3336600010017	1
2.5	30	57	750D02.5	3336600010024	1
3	33	61	750D03	3336600010031	1
3.2	36	65	750D03.2	3336600010048	1
3.5	39	70	750D03.5	3336600010055	1
4	43	75	750D04	3336600010062	1
4.2	43	75	750D04.2	3336600010079	1
4.5	47	80	750D04.5	3336600010086	1
5	52	86	750D05	3336600010093	1
5.2	52	86	750D05.2	3336600010109	1
5.5	57	93	750D05.5	3336600010116	1
6	57	93	750D06	3336600010123	1
6.5	63	101	750D06.5	3336600010130	1
7	69	109	750D07	3336600010147	1
7.5	69	109	750D07.5	3336600010154	1
8	75	117	750D08	3336600010161	1
8.5	75	117	750D08.5	3336600010178	1
9	81	125	750D09	3336600010185	1
9.5	81	125	750D09.5	3336600010192	1
10	87	133	750D10	3336600010208	1

Ø	WL	TL	Ref.	Gencod	Qty
Quadrapack of 5 pieces					
11	94	142	750D11	3336600010222	1
12	101	151	750D12	3336600010246	1
13	101	151	750D13	3336600010260	1
Quadrapack of 2 pieces					
14	108	160	750D14	3336600010284	1
15	114	169	750D15	3336600010307	1
16	120	178	750D16	3336600010321	1
18	130	191	750D18	3336600010369	1
20	140	205	750D20	3336600010406	1

ALL
SETS
PAGES 150-151

x10



752C

x19



775D

x25



776D

100% HSS

P.O.S ADVERTISING TO SPUR SALES



Ref. C00090



Ref. C00107



Display counter

To promote sets & cases
Ref. C00090

1 MÈTRE
DISPLAY

Unit range

Rack Presentation

HSS COBALT 5% drill bit - ref. 731

HSS G3 drill bit - ref. 702

HSS PRO drill bit - ref. 729

Set range

Quadropack range

HSS COBALT 5% drill bit - ref. 700

HSS G3 drill bit - ref. 703

HSS PRO drill bit - ref. 726



Display HSS counter

26 compartments
Opening on Front/Rear,
with key lock.
Ref. M00087

Features	Ref.	Gencod
1M SALES SHELF (to attribute with the pediment of your choice)	GOND1000	3336609000019
LUMINAR PEDIMENT FOR GOND1000	M00202	3336609009500
ELECTRIC CABLE FOR LUMINAR PEDIMENT (to attribute with each pediment command)	CORDON	3336600187528
DIAGER PEDIMENT FOR GOND1000	FR1000	3336609005472
ADJUSTABLE RACK WITH 20 DOUBLE HOOKS, 1M	RAT1000DOUBLE	3336609002211
ADJUSTABLE RACK WITHOUT HOOKS 1M	M00150	3336609004468
DOUBLE HOOK	M00151	3336609004475
SIMPLE HOOK	M00152	3336609004482
SHELF 900 MM ADJUSTABLE WIDTH DEPTH 360 MM	M00167	3336609006141
STORAGE UNIT WITH 2 DRAWERS (to attribute with 2 BAR1000 + ILV)	M00170	3336609006806
DISPLAY CASE (to attribute with 1 BAR1000)	M00157	3336609005274
1M STAY FOR 1M SALES SHELF	BAR1000	3336609000057
G3 MAGNET	B00357	3336609004987
COBALT MAGNET	B00358	3336609010520
HSS PRO MAGNET	B00359	3336609010537

Features	Ref.	Gencod
CARDBOARD COUNTER P.O.S	C00090	3336609005830
CARDBOARD P.O.S FOR SETS PRESENTATION	C00107	3336609007308
DISPLAY HSS COUNTER	M00087	3336609000194

Ref.
500B

Step drill TiAlN 5% cobalt

Step drill 4-12 mm

Step drill HSS 5% cobalt with TiAlN coating. Excellent heat resistance, wear limitation. Ideal for drilling in sheet metal or thin materials such as stainless steel, cast iron.



OVERHEATING RESISTANCE

Features

- HSS 5% cobalt fully ground.
- TiAlN coating.
- Tip angle 118°.
- Helicoidal flute.

Benefits

- Long life.
- Heating resistance.
- Drilling accuracy.
- Optimum clamping in the chuck.



Stainless steel, Alloy steel, Non-alloy steel, Cast iron, Cast iron, Spheroidal, Brass, Aluminum, Composite, Copper, Plastic

Shank



Cylindrical
3 flat

Angle



DIY tube

Capacity	Ø	TL	D	d	l1	Ref.	Gencod	Qty
4-5-6-7-8-9-10-11-12	4-12	79	12	6	5	500B	3336600144064	1

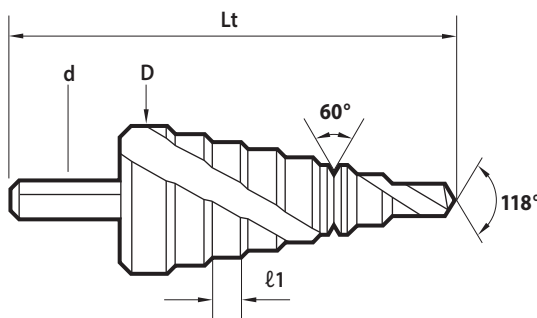

ALL SETS
PAGES 150-151



503C

Ref.
501B

Step drill 4-20 mm

Step drill HSS 5% cobalt with TiAlN coating. Excellent heat resistance, wear limitation. Ideal for drilling in sheet metal or thin materials such as stainless steel, cast iron.



DIY tube



Capacity	Ø	TL	D	d	l1	Ref.	Gencod	Qty
4-6-8-10-12-14-16-18-20	4-20	67	20	8	3	501B	3336600144071	1

Ref.
502B

Step drill 4-30 mm

Step drill HSS 5% cobalt with TiAlN coating. Excellent heat resistance, wear limitation. Ideal for drilling in sheet metal or thin materials such as stainless steel, cast iron.



DIY tube



Capacity	Ø	TL	D	d	l1	Ref.	Gencod	Qty
4-6-8-10-12-14-16-18-20-22-24-26-28-30	4-30	100	30	10	4	502B	3336600144088	1



Ref.
511B

Step drill

Step drill 4-20 mm

Step drill HSS fully ground with 118° angle for more precision and straight flute for easy resharpenering.

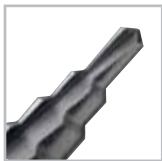

• DRILLING ACCURACY

Features

- HSS fully ground.
- Tip angle 118°.
- Cylindrical shank.

Benefits

- Drilling accuracy.



Alloy steel, Non-alloy steel, Cast iron
Spheroidal, Composite

Shank



Cylindrical

Angle



DIY tube

Capacity	Ø	TL	D	d	l1	Ref.	Gencod	Qty
4-6-8-10-12-14-16-18-20	4-20	67	20	8	3	511B	3336600194076	1

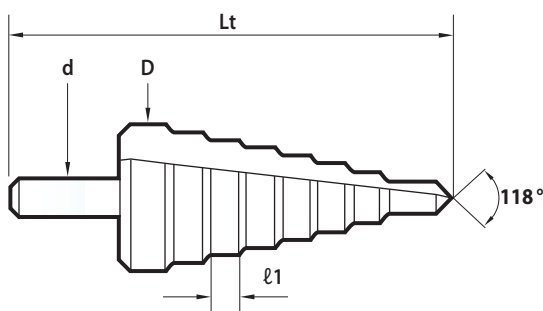

ALL
SETS
PAGES 150-151



513C

Ref.
512B

Step drill 4-30 mm

Step drill HSS fully ground with 118° angle for more precision and straight flute for easy resharping.



DIY tube



Capacity	Ø	TL	D	d	l1	Ref.	Gencod	Qty
4-6-8-10-12-14-16-18-20-22-24-26-28-30	4-30	100	30	10	4	512B	3336600194069	1

Ref.
513B

Step drill 6-38 mm

Step drill HSS fully ground with 118° angle for more precision and straight flute for easy resharping.



DIY tube



Capacity	Ø	TL	D	d	l1	Ref.	Gencod	Qty
6-9-13-16-19-21-23-26-29-32-35-38	6-38	100	38	10	4	513B	3336600194311	1



Ref.
867

Gun Tap

HSS machine tap

Tapping in alloy and non-alloy steels.



CUTTING PERFORMANCE

Features

- HSS fully ground tap.
- Din 376.

Benefits

- One step operation.
- Precision.



Alloy steel, Non-alloy steel

Shank Metrical thread



Square

M



Round or square tube

Ø of drilling	Ø of tapping (Ø x Pas)	WL	TL	Ref.	Gencod	Qty
2.5	M3 x 0.50	11	56	867D03	3336600020368	1
3.3	M4 x 0.70	13	63	867D04	3336600020375	1
4.2	M5 x 0.80	16	70	867D05	3336600020382	1
5	M6 x 1.00	19	80	867D06	3336600020399	1
6.8	M8 x 1.25	22	90	867D08	3336600020405	1
8.5	M10 x 1.50	24	100	867D10	3336600020412	1
10.2	M12 x 1.75	29	110	867D12	3336600020429	1
12	M14 x 2.00	30	110	867D14	3336600020436	1
14	M16 x 2.00	34	110	867D16	3336600020443	1

ALL SETS
PAGES 150-151

x31



078E

x15



076E

Ref.
U505

Screw extractor



Features

- High quality steel.
- Reversed pitch, left hand pitch.
- Black finish.

Advices

- For the tool holder : use left-hand turn, for large diameters : spanner, for small spaces : flat or ratchet spanner.

Ø	Ref.	Gencod	Qty
1-6	U5050163	4019321501635	1
1-8	U5050183	4019321501833	1

Shank



Square



Screw to extract	Ø Drilling	N° Extractor	SW mm	N° adjustable tap wrench	Adjustable spanner
M3-6	2.50	1	3.20	1	yes
M6-8	3	2	4	1-2	yes
M8-11	4.50	3	5.20	1-2	yes
M11-14	6	4	6.40	2-3	yes
M14-18	8	5	8.85	3	yes
M18-24	11	6	11.80	3	yes
M24-33	14	7	15	-	yes
M33-50	21	8	20	-	yes



Ref.
504

Countersink

Features

- 3 cutting edges.
- Countersink angle 90°.
- Din 335C.
- Cylindrical shank.

Benefits

- Extremely sharp edges.
- Deburring and countersinking.



Stainless steel, Non-alloy steel, Aluminum

Shank



Cylindrical

Angle



DIY tube

Ø	WL	Ref.	Gencod	Qty
6.3	45	504D06.3	3336600173453	1
8.3	50	504D08.3	3336600166738	1
10.4	50	504D10.4	3336600166745	1
12.4	56	504D12.4	3336600166752	1
16.5	56	504D16.5	3336600166769	1
20.5	63	504D20.5	3336600166776	1



Ref.
D2409

TCT HSS drill bit

HSS carbide tipped drill bit

HSS carbide tipped drill bit, K20 carbide tip brazed at very high temperature for drilling hard metal.

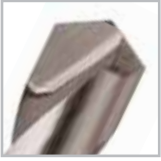

• HIGH PRECISION

Features

- Point angle 118°.
- Right cut 6°.
- Helix angle 25° type N.
- DIN 338.

Advices

- To be use on a column drill or machine center.



Stainless steel, Alloy steel, Non-alloy steel,
Cast iron, Cast iron, Spheroidal, Aluminum,
Titanium alloy, Copper, Plastic

Shank



Cylindrical

Angle



Sharpening



Ø	WL	TL	Ref.	Gencod	Qty
Short series					
1.5	18	40	D2409D0150	3336600121287	1
2	24	49	D2409D0200	3336600121331	1
2.5	30	57	D2409D0250	3336600121386	1
3	33	61	D2409D0300	3336600121430	1
3.2	36	65	D2409D0320	3336600121454	1
3.3	36	65	D2409D0330	3336600121461	1
3.5	39	70	D2409D0350	333660012v5	1
4	43	75	D2409D0400	3336600121539	1
4.2	43	75	D2409D0420	3336600121553	1
4.5	47	80	D2409D0450	3336600121584	1
4.8	52	86	D2409D0480	3336600121614	1
5	52	86	D2409D0500	3336600121638	1
5.2	52	86	D2409D0520	3336600121652	1
5.5	57	93	D2409D0550	3336600121683	1
6	57	93	D2409D0600	3336600121737	1
6.5	63	101	D2409D0650	3336600121782	1
7	69	109	D2409D0700	3336600121836	1
7.5	69	109	D2409D0750	3336600121881	1
8	75	117	D2409D0800	3336600121935	1
9	81	125	D2409D0900	3336600122031	1
9.5	81	125	D2409D0950	3336600122086	1
10	87	133	D2409D1000	3336600122130	1
10.5	87	133	D2409D1050	3336600122154	1
11	94	142	D2409D1100	3336600122161	1
11.5	94	142	D2409D1150	3336600122185	1
12	101	151	D2409D1200	3336600122192	1
12.5	101	151	D2409D1250	3336600122215	1
13	101	151	D2409D1300	3336600122222	1
13.5	108	160	D2409D1350	3336600122239	1
14	108	160	D2409D1400	3336600122246	1
15	114	169	D2409D1500	3336600122260	1
15.5	120	178	D2409D1550	3336600122277	1
16	125	184	D2409D1600	3336600122284	1



Grey plastic pouch

Ø	WL	TL	Ref.	Gencod	Qty
16.5	125	184	D2409D1650	3336600122291	1
17	125	184	D2409D1700	3336600122307	1
17.5	130	191	D2409D1750	3336600122314	1
18	130	191	D2409D1800	3336600122321	1
18.5	135	198	D2409D1850	3336600122338	1
19	135	198	D2409D1900	3336600122345	1
19.5	140	205	D2409D1950	3336600122352	1
20	140	205	D2409D2000	3336600122369	1

ALL SETS
PAGES 150-151

x6



507C

Ref.
D2418

TCT HSS drill bit

HSS carbide tipped drill bit long serie

HSS carbide tipped drill bit, K20 carbide tip brazed at very high temperature for dilling hard metal.

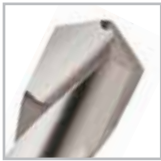

• HIGH PRECISION

Features

- Point angle 118°.
- Right cut 6°.
- Helix angle 25° type N.
- DIN 340.

Advices

- To be use on a column drill or machine center.



Stainless steel, Alloy steel, Non-alloy steel,
Cast iron, Cast iron, Spheroidal, Aluminum,
Titanium alloy, Copper, Plastic

Shank



Cylindrical

Angle



Sharpening



Ø	WL	TL	Ref.	Gencod	Qty
Long series					
1.8	53	80	D2418D0180	3336600129894	1
2	56	85	D2418D0200	3336600129917	1
2.5	62	95	D2418D0250	3336600129962	1
3	66	100	D2418D0300	3336600130012	1
3.5	73	112	D2418D0350	3336600130067	1
4	78	119	D2418D0400	3336600130111	1
4.5	82	126	D2418D0450	3336600130166	1
5	87	132	D2418D0500	3336600130210	1
5.5	91	139	D2418D0550	3336600130265	1
6	91	139	D2418D0600	3336600130319	1
6.5	97	148	D2418D0650	3336600130364	1
7	102	156	D2418D0700	3336600130418	1
8	109	165	D2418D0800	3336600130517	1
8.5	109	165	D2418D0850	3336600130562	1
9.5	115	175	D2418D0950	3336600130586	1
10	121	184	D2418D1000	3336600130593	1
10.5	121	184	D2418D1050	3336600130609	1
11	128	195	D2418D1100	3336600130616	1
11.5	128	195	D2418D1150	3336600130623	1
12	134	205	D2418D1200	3336600130630	1
12.5	134	205	D2418D1250	3336600130647	1
13	134	205	D2418D1300	3336600130654	1
13.5	140	214	D2418D1350	3336600130661	1
14	140	214	D2418D1400	3336600130678	1
14.5	144	220	D2418D1450	3336600130685	1
16	149	227	D2418D1600	3336600130708	1
17	154	235	D2418D1700	3336600130715	1
18	158	241	D2418D1800	3336600130722	1
19	162	247	D2418D1900	3336600130739	1
20	166	254	D2418D2000	3336600130746	1



Grey plastic pouch

METAL

HSS STANDARD



HSS PRO



HSS COBALT 5%



Features

Pcs

Type

Composition

Ref.

Gencod

Features	Pcs	Type	Composition	Ref.	Gencod
STANDARD	10	Set	HSS Rolled Forged Ø1-10 mm	752C	3336600007116
STANDARD	19	Metal set	HSS Rolled Forged Ø1 à 10 mm par 0,5 mm	775D	3336600025745
STANDARD	25	Metal set	HSS Rolled Forged Ø1 à 13 mm par 0,5 mm	776D	3336600025752
COBALT 5%	6	Solo	HSS Cobalt 5% Ø2-3-4-5-6-8 mm	706C	3336600007185
COBALT 5%	10	Duo	HSS COBALT 5% Ø1-10 mm	720C	3336600083547
COBALT 5%	19	Set	HSS COBALT 5% Ø1-10 mm / 0,5 mm	708D	3336600182226
COBALT 5%	25	Set	HSS COBALT 5% Ø1-13 mm / 0,5 mm	707D	3336600160408
PRO	6	Solo	GROUND HSS PRO Ø2-3-4-5-6-8 mm	700C	3336600007123
PRO	10	Duo	GROUND HSS PRO Ø1-10 mm	718C	3336600083561
PRO	13	Duo	GROUND HSS PRO Ø1,5-6,5 mm / 0,5 mm +3,2-4,2 mm	719C	3336600083554
PRO	19	Metal set	GROUND HSS PRO Ø1-10 / 0,5 mm	745D	3336600025769
PRO	25	Metal set	GROUND HSS PRO Ø1-13 / 0,5 mm	747D	3336600025776
PRO	170	Case	GROUND HSS PRO Ø1-10 / 0,5 mm	206E	3336600182219

G3



Features	Pcs	Type	Composition	Ref.	Gencod
MULTI-LAYERS COATING G3	19	Set	HSS G3 19 set HSS 3G Ø1-10 mm / 0,5 mm	705D	3336600160385
MULTI-LAYERS COATING G4	25	Set	HSS G3 25 set HSS 3G Ø1-13 mm / 0,5 mm	706D	3336600160392
MULTI-LAYERS COATING G5	170	Case	HSS G3 19 set HSS 3G Ø1-10 mm / 0,5 mm	203E	3336600181090
TCT HSS DRILL BIT	6	Set	Tip Drill Bit D2409 Ø3-4-5-6-8-10 mm	507C	3336600157699
SET OF TAPES AND DIES	31	Case	Tap M3-4-5-6-8-10-12 Die M3-4-5-6-8-10-12 - 1 Adjustable tap wrench + 1 Die holder + 1 tool	078E	3336600167537
SET OF TAPES AND DIES	15	Set	TAP & DRILL BIT 15 set Drill bit HSS Ø2,5-3,3-4,2-5-6-8-8,5-10,2 mm Tap M3-4-5-6-8-10-12 + 1 Adjustable tap wrench	076E	3336600168152
CONICAL CUTTER	5	Set	HSS 90° Cobalt Ø8,3-10,4-12,4-16,5-20,5 mm	505C	3336600144118
CONICAL CUTTER	5	Set	HSS 90° Ø8,3-10,4-12,4-16,5-20,5 mm	504C	3336600144101
STEP DRILL BIT COBALT TIALN	3	Set	5% Cobalt TIALN Step drill bit 4 to 12 - 4 to 20 - 4 to 30	503C	3336600144095
STEP DRILL BIT	3	Set	Step drill bit 4 to 12 - 4 to 20 - 4 to 30	513C	3336600194083
SCREW EXTRACTOR	6	Set	Screw extractor N°1 à 6	U5050163	4019321501635
SCREW EXTRACTOR	8	Set	Screw extractor N°1 à 8	U5050183	4019321501833



Ref.
912-913
914-946

Wood auger bit PRO

Hexagonal shank



High quality auger drill bit, the hardened head and cutting edge guarantees high endurance. Its thread and precision sharpening allows clean and fast drilling.



Exotic wood, Low density wood, Hard wood,
Laminate

ALL
SETS
PAGES 166-167



913C

Ø	WL	TL	Ref.	Gencod	Qty
Hex shank - L1080					
12	1000	1080	946D12	3336600186668	1
14	1000	1080	946D14	3336600186675	1
16	1000	1080	946D16	3336600186682	1
18	990	1080	946D18	3336600186699	1
20	990	1080	946D20	3336600186705	1
22	990	1080	946D22	3336600186712	1
24	990	1080	946D24	3336600186729	1
26	990	1080	946D26	3336600186736	1
28	980	1080	946D28	3336600186743	1
30	980	1080	946D30	3336600186750	1
32	980	1080	946D32	3336600186767	1



DIY tube



DIY tube



• SPEED AND ROBUSTNESS

Features

- Self-centring threaded point.
- Head sharpening precision.
- Fully heat treated.

Benefits

- Deep and fast drilling.
- Clean cut.

Shank



Hexagonal

Ø	WL	TL	Ref.	Gencod	Qty
Hex shank - L235					
4*	100	180	912D04	3336600153066	1
6*	160	235	912D06	3336600153073	1
8	160	235	912D08	3336600153080	1
10	160	235	912D10	3336600153097	1
12	160	235	912D12	3336600153103	1
14	155	235	912D14	3336600153110	1
16	155	235	912D16	3336600153127	1
18	155	235	912D18	3336600153134	1
20	155	235	912D20	3336600153141	1
22	150	235	912D22	3336600153158	1
24	155	235	912D24	3336600152854	1
26	155	235	912D26	3336600152830	1
28	150	235	912D28	3336600152847	1
32	150	235	912D32	3336600153387	1

* Straight shank

Ø	WL	TL	Ref.	Gencod	Qty
Hex shank - L460					
8	375	460	913D08	3336600152861	1
10	380	460	913D10	3336600152878	1
12	380	460	913D12	3336600152885	1
14	380	460	913D14	3336600152892	1
16	380	460	913D16	3336600152908	1
17	380	460	913D17	3336600153042	1
18	380	460	913D18	3336600152915	1
20	380	460	913D20	3336600152922	1
22	380	460	913D22	3336600152939	1
24	380	460	913D24	3336600152946	1
25	380	460	913D25	3336600194984	1
26	380	460	913D26	3336600152953	1
28	380	460	913D28	3336600152960	1
30	370	460	913D30	3336600153059	1
32	370	460	913D32	3336600152977	1

Ø	WL	TL	Ref.	Gencod	Qty
Hex shank - L600					
12	530	600	941D12	3336600153165	1
14	525	600	941D14	3336600153172	1
16	525	600	941D16	3336600153189	1
18	520	600	941D18	3336600153196	1
20	520	600	941D20	3336600153202	1
22	520	600	941D22	3336600153219	1
24	520	600	941D24	3336600153226	1

Ref.
942
943

Wood auger bit PRO

Compatible SDS-plus



High quality auger drill bit, the hardened head and cutting edge guarantees high endurance. Its thread and precision sharpening allows clean and fast drilling.



• SPEED AND ROBUSTNESS

Features

- Self-centring threaded point.
- Head sharpening precision.
- Fully heat treated.

Benefits

- Deep and fast drilling.
- Clean cut.



Exotic wood, Low density wood, Hard wood, Laminate

Shank



Compatible
SDS-plus

Ø	WL	TL	Ref.	Gencod	Qty
Compatible SDS-pWLs - L235					
6	90	200	942D06	3336600153233	1
8	90	200	942D08	3336600153240	1
10	160	235	942D10	3336600153257	1
12	160	235	942D12	3336600153264	1
14	155	235	942D14	3336600153271	1
16	155	235	942D16	3336600153288	1
18	155	235	942D18	3336600153295	1
20	155	235	942D20	3336600153301	1

ALL
SETS
PAGES 166-167

x5



943C



DIY tube

Ø	WL	TL	Ref.	Gencod	Qty
Compatible SDS-pWLs - L400					
10	320	400	943D10	3336600153318	1
12	320	400	943D12	3336600153325	1
14	320	400	943D14	3336600153332	1
16	320	400	943D16	3336600153349	1
18	320	400	943D18	3336600153356	1
20	320	400	943D20	3336600153363	1
22	320	400	943D22	3336600153370	1
24	320	400	943D24	3336600178274	1
26	320	400	943D26	3336600178281	1
28	320	400	943D28	3336600178298	1

Ref.
904

Flat wood bit

Quick-lock shank 6,35 mm

Flat drill bit for drilling hard and soft woods, fits on drill or screwdriver with its quick-lock attachment. The rigidity of the shaft and the ground centering point enable fast and clean drilling.



• FAST, PRECISE AND CLEAN DRILLING

Features

- Centering point.
- Grinded chip breaker.
- High quality steel.
- Rigidity of the axis.

Benefits

- Fast drilling.
- Clean cut.
- Greater rigidity.

Applications

- Fast drilling in all wood type.



Exotic wood, Low density wood, Hard wood,
Plywood, Plaster, Laminate

Shank



Quick Lock
1/4" - 6.35



Quality plastic
pouch

Ø	TL	Ref.	Gencod	Qty
Hex shank				
6	152	904D06	3336600028715	1
8	152	904D08	3336600009844	1
10	152	904D10	3336600009851	1
12	152	904D12	3336600009868	1
13	152	904D13	3336600028722	1
14	152	904D14	3336600009875	1
16	152	904D16	3336600009882	1
18	152	904D18	3336600009899	1
19	152	904D19	3336600028739	1
20	152	904D20	3336600009905	1
22	152	904D22	3336600009912	1
24	152	904D24	3336600009929	1
25	152	904D25	3336600009936	1
26	152	904D26	3336600009943	1
28	152	904D28	3336600009950	1
30	152	904D30	3336600009967	1
32	152	904D32	3336600009974	1
35	152	904D35	3336600009981	1

ALL
SETS
PAGES 166-167

x9



925C

Ref. **906** Wood drill bits accessories



Etui Quality transparent

Flat wood bit extension quick lock shank 1/4».



TL	Ref.	Gencod	Qty
270	906	3336600012110	1



Ref. **908** Wood drill bits accessories



Etui Quality transparent

Extensible drill head 15-45 mm for wood drilling.



Ø	TL	Ref.	Gencod	Qty
15 a 45	122	908	3336600012127	1

Ref. **938C** Wood drill bits accessories



Tube DIY

Set 5 adjuster collar for drill bit 4-5-6-8-10 mm.



Ø	Ref.	Gencod	Qty
4/5/6/8/10	938C	3336600145795	1



Ref. **939** Wood drill bits accessories



Tube DIY

Countersink for wood countersunk head screw.



Ø	TL	Ref.	Gencod	Qty
3	25	939D03	3336600145801	1
4	25	939D04	3336600145818	1
5	25	939D05	3336600145825	1



Ref.
934

Forstner woodmax

Forstner wood drill bit

Features

- Self centerign point.
- 2 central blades.
- 2 lateral cutters.
- Specific teeth geometry.

Benefits

- Clean and precise cut.
- Fast cutting.
- Limited heating.



Hard wood, Wooden plate, Plywood

Shank



Hexagonal
8 or 10 mm



Twistpack

Ø	WL	TL	Ref.	Gencod	Qty
Hex Shank					
*15	57	90	934D15	3336600145474	1
*18	57	90	934D18	3336600145498	1
*20	57	90	934D20	3336600145504	1
22	57	90	934D22	3336600145511	1
25	57	90	934D25	3336600145528	1
30	57	90	934D30	3336600145542	1
35	57	90	934D35	3336600145559	1
40	57	90	934D40	3336600145566	1
45	57	90	934D45	3336600145573	1
50	57	90	934D50	3336600145580	1
*Shank - 8 mm					

ALL
SETS
PAGES 166-167



940D



Ref.
723M

Formwork drill bit

Cylindrical shank

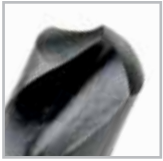

Formwork HSS drill bit, allows multi-layer drilling. Useful for renovation work, drilling cladding with insulation, wood formwork, ...



• MULTI-LAYERS DRILLING

Features

- Point angle 118°.
- HSS Quality.

Benefits

- Long drilling length.
- Multi-purpose use.

Applications

- Renovation work.



Low density wood, Alloy steel, Laminate

Shank



Cylindrical

Use



Without percussion



Plastic pouch

Ø	WL	TL	Ref.	Gencod	Qty
Straight Shank					
8	360	400	723MD08	3336600116634	1
10	360	400	723MD10	3336600116641	1
12	360	400	723MD12	3336600116658	1
14	360	400	723MD14	3336600116665	1
16	360	400	723MD16	3336600116672	1
18	360	400	723MD18	3336600116689	1
20	360	400	723MD20	3336600116696	1
24	340	400	723MD24	3336600116702	1

Ref.
722M

Compatible SDS-plus

Formwork HSS drill bit, allows multi-layer drilling. Useful for renovation work, drilling cladding with insulation, wood formwork, ...



Black plastic clip

Ø	WL	TL	Ref.	Gencod	Qty
Compatible SDS-PW/Ls					
10	340	400	722MD10	3336600164550	1
12	340	400	722MD12	3336600164567	1
14	340	400	722MD14	3336600164574	1
16	340	400	722MD16	3336600164581	1
18	340	400	722MD18	3336600164598	1
24	340	400	722MD24	3336600164611	1

Ref.
910

4 point wood drill bit

Cylindrical shank



Fast and precise, the 4-point geometry provides better wear resistance and increases life time.



• DRILLING IN ALL TYPES OF WOOD

Features

- Self centering point.
- 3 cutting edges.

Benefits

- Clean and precise cut.
- Fast cutting.



Exotic wood, Hard wood, Low density wood,
Composite

Shank



Cylindrical



Quality plastic
pouch

Ø	WL	TL	Ref.	Gencod	Qty
Straight Shank					
3	22	62	910D03	3336600155138	1
4	35	75	910D04	3336600154537	1
5	46	86	910D05	3336600147348	1
6	53	93	910D06	3336600147355	1
8	77	117	910D08	3336600147362	1
10	93	133	910D10	3336600147379	1
12	111	151	910D12	3336600147386	1

ALL
SETS
PAGES 166-167



910D

Ref.
915

3 point wood drill bit

Cylindrical shank

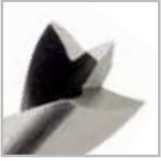

Realise clean hole thanks to the centering tip and the 2 cutting edges. For all types of wood.



• PRECISION

Features

- Self centering point.
- 2 cutting edges.
- Width and polished margin.

Benefits

- Accuracy.
- Clean cut.
- Performance.

Applications

- Renovation wood furniture.



Hard wood, Low density wood, Laminate, Plywood

Shank



Cylindrical



Quality plastic pouch

Ø	WL	TL	Ref.	Gencod	Qty
Short series					
3	21	61	915D03	3336600011984	1
4	35	75	915D04	3336600011991	1
5	46	86	915D05	3336600012004	1
6	53	93	915D06	3336600012011	1
7	69	109	915D07	3336600012028	1
8	77	117	915D08	3336600012035	1
9	85	125	915D09	3336600012516	1
10	93	133	915D10	3336600012042	1
11	102	142	915D11	3336600013124	1
12	111	151	915D12	3336600012059	1
13	111	151	915D13	3336600012066	1

ALL SETS
PAGES 166-167

x5



907B

x8



917B

x7



905D

Ref.
902
903

Decking kit

Complete kit : drills bits, countersink with depth stop, double hex wrench

This set allow you to pre-drill calibered holes for the used screws and hide their heads in the same time thank to auto-adjusting carbide countersink.



• ADJUSTABLE DEPTH

Features

- 3x $\varnothing 4$ mm bits or $\varnothing 4,5$ mm bits, one 45° chamfer, carbide plates, one low friction depth stop, one double hex wrench.

Benefits

- Screw compatible from $\varnothing 4,5$ to 6 mm for $\varnothing 4$ mm drill bit or $\varnothing 5,5$ to 7 mm for $\varnothing 4,5$ mm drill bit.
- Chamfer bit with carbide plates for a longer service life.
- The drilling and chamfering depths can be accurately adjusted.
- The user can easily set the drilling depth without even have to remov the depth stop.

Applications

- Drilling in series for wood terrace.



Exotic wood, Hard wood

Shank



Quick Lock
1/4" - 6.35

ALL
SETS
PAGES 166-167



Twistpack
incolor

\varnothing	Ref.	Gencod	Qty
4	902D04	3336600173842	1
4.5	902D04.5	3336600187344	1

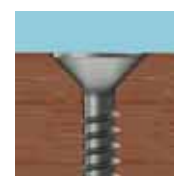

Decking kit for countersunk
head screw



Twistpack
incolor

\varnothing	Ref.	Gencod	Qty
4	903D04	3336600202177	1

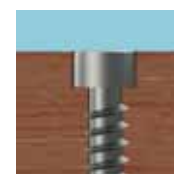

Decking kit for
pan head screws

Ref.
911

Accessories for decking kit

Replacement drill bits for Diager decking kit 902D.



Ø	WL	TL	Ref.	Gencod	Qty
Decking bit (x3items)					
4	25	55	911D04	3336600173859	1
4.5	25	55	911D04.5	3336600187351	1

Ref.
919

Accessories for decking kit

Replacement drill bits for Diager decking kit 903D.



Ø	WL	TL	Ref.	Gencod	Qty
Decking bit (x3items)					
4	40	75	919D04	3336600202184	1

CARBIDE COUNTERSINK 45°

DRILL BIT Ø4 mm
Compatible screws Ø4.5 until 6 mm

DEPTH STOP
Free rotation = anti-friction

QUICK-LOCK 6,35
Optimal holding in the chuck

QUICK LOCK

FOR 2 TYPES OF SCREWS

FOR COUNTERSUNK HEAD SCREWS
Complete kit ref. 902

FOR PAN HEAD SCREWS
Complete kit ref. 903

WOOD



925C



905D



907B

917B

910D



9000A

9000B

Features	Pcs	Type	Composition	Ref.	Gencod
FLAT WOOD BIT	9	Set	9 FLATS BIT QUICK-LOCK Ø14-16-18-20-22-24-26-28-30 mm	925C	3336600168428
3 POINT WOOD DRILL BIT	7	Set metal	BRAD POINT BIT Ø4-5-6-8-10-12 mm	905D	3336600007680
3 POINT WOOD DRILL BIT	5	Solo	BRAD POINT BIT Ø3-4-5-6-8 mm	907B	3336600108455
3 POINT WOOD DRILL BIT	8	Duo	BRAD POINT BIT Ø3-4-5-6-8-10 mm	917B	3336600075702
4 POINT WOOD DRILL BIT	5	Solo	4 WOOD Ø3-4-5-6-8 mm	910D	3336600157040
DECKING KIT	15	kit	Complete kit : 3 x Ø4 mm bits, One 45° chamfer - carbide plates - Ø4 mm quick lock attachment, One « low friction » depth stop, One double hex wrench, Ref 911D04 - Spare drill bits	9000A	3336600199620
DECKING KIT	15	kit	Complete kit : 3 x Ø4,5 mm bits, One 45° chamfer - carbide plates - Ø4 mm quick lock attachment, One « low friction » depth stop, One double hex wrench, Ref 911D04 - Spare drill bits	9000B	3336600202221

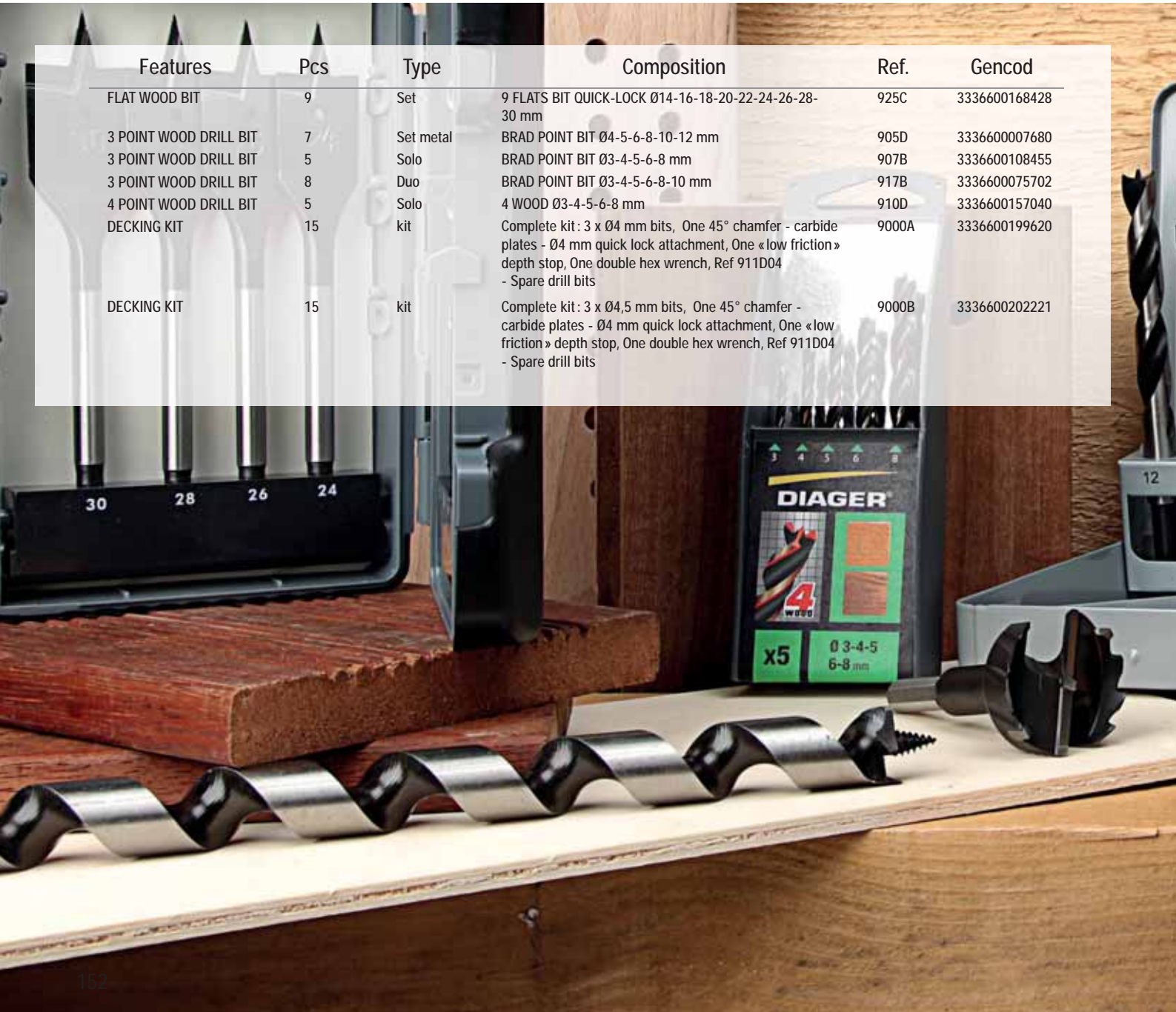

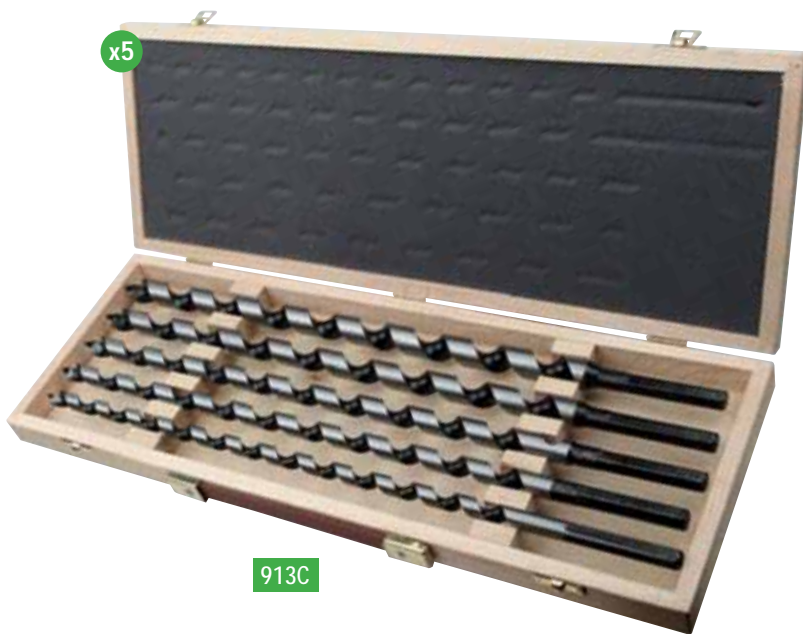

Features	Pcs	Type	Composition	Ref.	Gencod
AUGER BIT PRO HEX	5	Case	AUGER BIT PRO HEXAGONAL L460 mm Ø12-14-16-18-20 mm	913C	3336600157583
AUGER BIT PRO SDS PLUS	5	Case	AUGER BIT PRO compatible SDS-plus L400 mm Ø12-14-16-18-20 mm	943C	3336600157590
FORSTNER WOODMAX	5	Case	FORSTNER WOODMAX Ø15-20-25-30-35 mm	940D	3336600146839

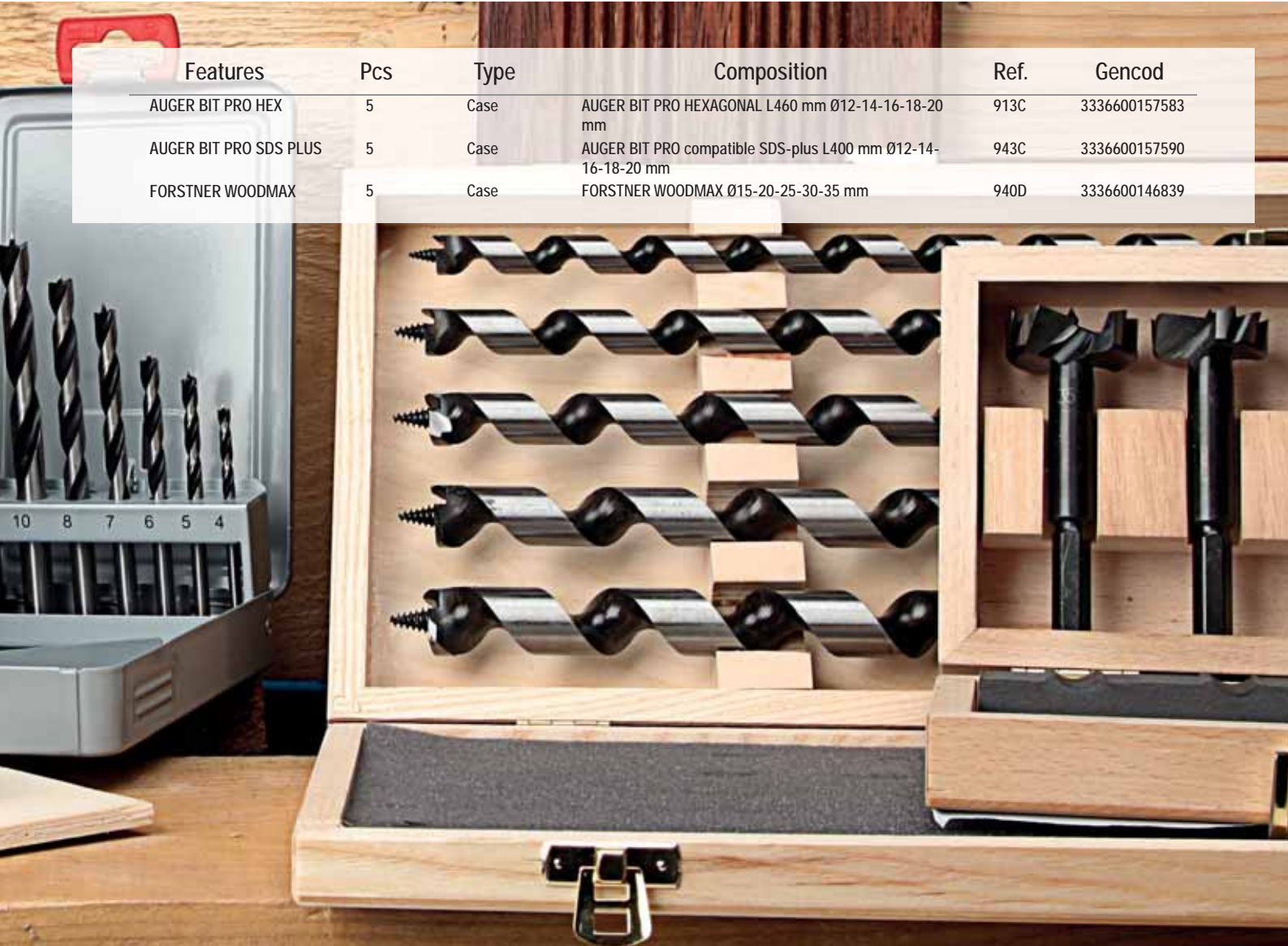

DRILLING

Hammer drill bit SDS-plus

Ø	Rotation speed rpm
3	850
4	850
5	850
6	850
7	850
8	650
9	650
10	650
11	650
12	650
13	650
14	650
16	650
18	650
20	650
22	650
24	650
26	650
28	650
30	650
30 and +	650

Drill bit

Ø	Rotation speed rpm	
	Short series	Long series
3	3 185	-
4	2 390	-
5	1 910	-
6	1 590	800
7	1 365	800
8	1 195	900
9	1 060	900
10	955	955
11	870	870
12	800	800
13	735	735
14	680	680
16	600	600
18	530	530
20	475	475
22	435	430
24	400	400
26	365	370
28	340	340
30	320	320

To note: the rotation speed of the drill bit FQC are limited for security reason in use of drill bits. Indeed, in case of important runout, the drill bit could bend and hit the user.

HSS drill bit

Ø	Rotation speed rpm	
	Steel 750N/mm ²	Steel 1100N/mm ²
1	6 400	3200
2	3 200	1590
3	2 120	1060
4	1 590	795
5	1 275	635
6	1 060	530
7	910	455
8	800	400
9	700	355
10	640	320
11	580	290
12	530	265
13	500	245
14	455	225
16	400	200
18	355	175
20	320	160
22	290	145
24	265	135
26	245	120
28	225	115
30	210	105

Drilling only in rotation.

Multimaterials drill bit

Ø	Rotation speed rpm					
	Plastic	Steel 750N/mm ²	Steel 1100N/mm ²	Glass	Hard wood	Plywood
4	4 775	1 590	795	400	3 000	3 000
6	3 185	1 060	530	285	3 000	3 000
8	2 385	800	400	220	3 000	3 000
10	1 910	640	320	170	3 000	3 000
12	1 590	530	265	140	1 500	1 500
14	1 365	455	225	125	1 500	1 500
16	1 195	400	200	110	1 500	1 500

Drilling only in rotation.

Glass drill bit

Ø	Rotation speed rpm
3	500
4	400
5	330
6	285
8	220
10	170
12	140
14	125

Drilling only in rotation in non-tempered glass with water, in ceramic (porcelain), in faience.

ROTATION SPEED

Tips and maintenance hammer drill

MAINTENANCE OF THE HAMMER DRILL

For more efficient drilling, maintain the chuck of your drill or hammer drill to keep it clean and lubricated. Replace worn parts. You always have a dust cap in good condition on the chuck that reduces its wear and get better performance with the drill bit.

THE DRILL BIT

A twisted drill bit will not make a circular hole.

Always keep the attachment of your drills bits clean on the cleaner with a cloth and lubricated with the recommended grease.

TIPS FOR IMPLEMENTATION

Always use a machine compatible with the drill bit used, for this it is advisable to consult the instructions to use of the machine.

See also our compatibility tables.

For demonstrations, never drill beyond the cutting length of the bit. Drilling deeper can result in obstruction of the hole and premature failure of the drill.

When drilling, it is strongly recommended to carry out frequent deburrings.

The pressure exerted on the machine must be constant and uniform. For better performance, it is important to let the punch work, so the pressure on the machine should not be too strong. Excessive pressure can also cause heat of the drill bit and on the carbide tip and increase the risk of breakage.

You must be in a stable and adequate position while drilling.

The drilling must be done in an axis perpendicular to the material to be drilled. Drilling in an oblique axis will damage the drill bit.



Flat bit

Ø	Rotation speed rpm
8	2785
9	2500
10	2230
11	2030
12	1860
13	1715
14	1590
16	1395
18	1240
20	1115
22	1015
24	930
26	860
28	800
30	745
32	700
35	640

Drilling only in rotation.

Auger bit

Ø	Rotation speed rpm	
	Low density wood	Hard wood
8	3 000	2 090
9	2 970	2 040
10	2 900	1 900
11	2 880	1 765
12	2 825	1 615
13	2 735	1 500
14	2 630	1 410
15	2 500	1 250
16	2 425	1 205
17	2 325	1 130
18	1 060	1 060
19	1 000	1 000
20	900	900
21	880	880
22	855	855
23	810	810
24	780	780
25	700	700

Wood drill bit

Ø	Rotation speed rpm	
	Low density wood	Hard wood
3	5 625	4 985
4	4 220	3 740
5	3 375	2 990
6	2 810	2 495
7	2 410	2 135
8	2 110	1 870
9	1 875	1 660
10	1 690	1 495
11	1 535	1 360
12	1 405	1 245
13	1 300	1 150
14	1 205	1 070
16	1 055	935
18	935	830
20	845	750

Drilling only in rotation.

These rotation speed doesn't apply to drilling: treated wood, exotic woods, green wood, glued laminate wood. Drilling only in rotation.

IMPACT bits

BLUE SHOCK

Length 30 and 50 mm

For use on an impact driver and high power screwdriver.
DIN 3126 C6.3 compatible E6.3 -
DIN 3126 E6.3

Made in GERMANY



- PHILIPS
- POZIDRIV
- TORX
- HEXA
- CARRÉ

STAINLESS STEEL bits

No risk of rust, allows outside work. Recommended to use with stainless steel screws.
DIN 3126 C6.3

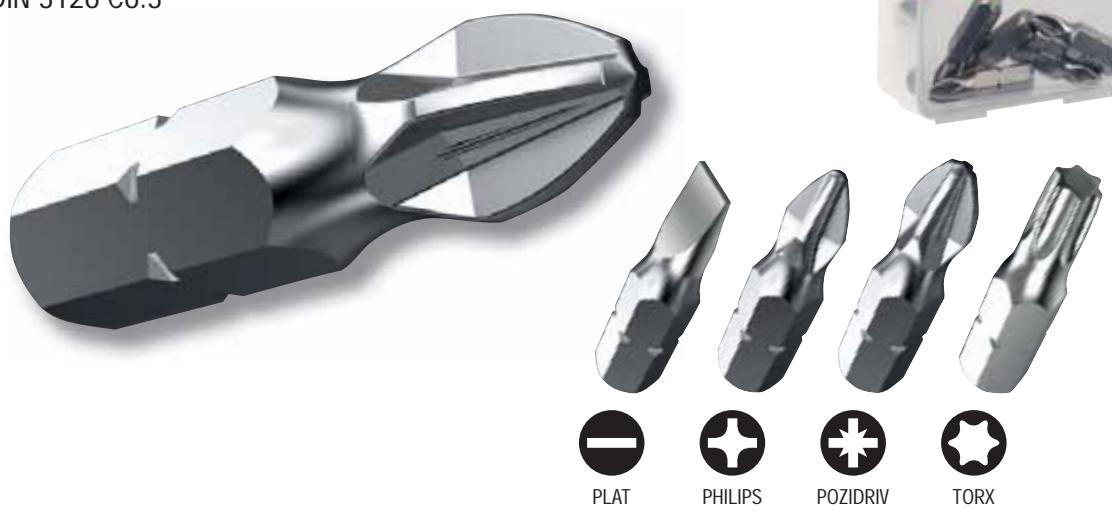

- PLAT
- PHILIPS
- POZIDRIV
- TORX

INOX

INOX



PRO bits

Length 25 until 150 mm

Adapts perfectly to all DIN screws.
 Standard DIN hardness. Optimal concentricity.
 Perfect transmission of the tightening torque.
 DIN 3126 C6.3 - DIN 3126 E6.3

Made in
GERMANY



TORSION FLEX

Torsion geometry
 for higher
 strength against
 the tightening
 torque.



Reduced section bits
 for difficult access
 Length until 150 mm



Impact bit **BLUE SHOCK**

Anti-Breakage

The flex zone is reinforced on each side for an even stronger link with the head and the attachment and avoid breakages.

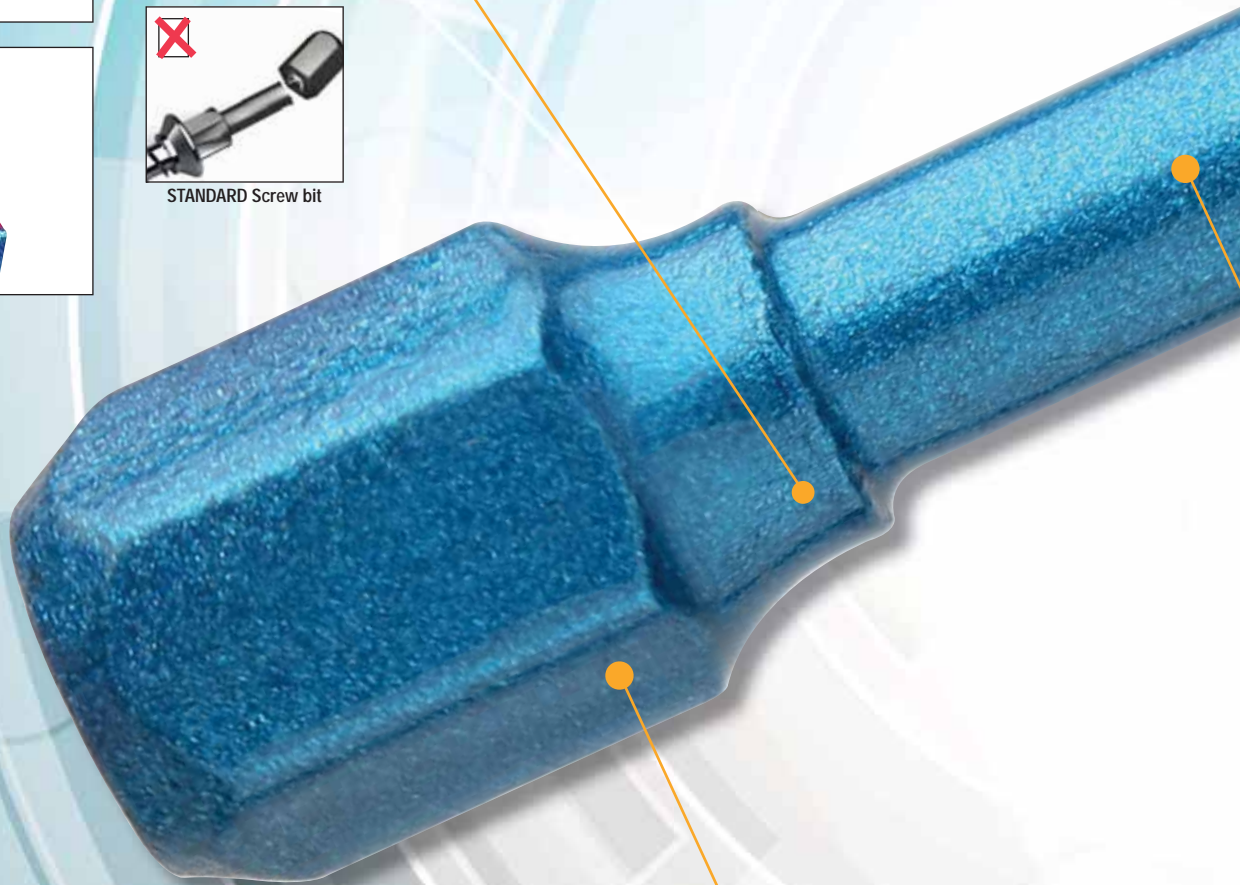
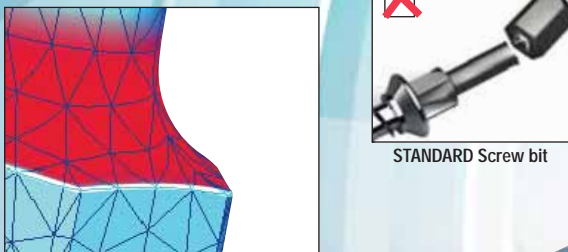
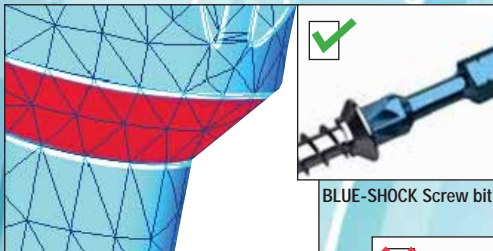

Special impact screwdriver shank

Adapts perfectly to the quick lock system of impact screwdrivers thanks to a DIN E 6.3 compatible shank.



BLUE-SHOCK screw bit
Compatible DIN E 6.3



DIN C 6.3 screw bit

Range available with



PH PZ TX SQ HEX

Reinforcement

A strong ring reinforces the head for an even longer resistance.

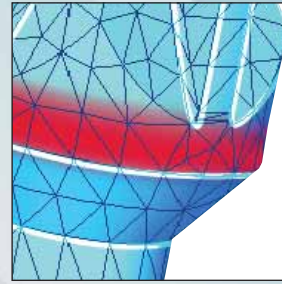

BLUE-SHOCK Screw bit

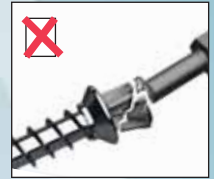

STANDARD Screw bit

Upper length

Thanks to its longer length (30 mm), the bit protrudes perfectly from the screwdriver chuck.



BLUE-SHOCK Screw bit
30 mm



Screw bit 25 mm

Clean and precise screwing

PH, PZ, TX perfectly fits screwheads and avoid slipping and destroying head geometry.



Resist to violent impacts

The Blueshock screw bit offers a special design with elongated torsion zone, resisting to high torque and violent impacts. Its hardness suits the most powerful machines



Ref.
U610



Blue-Shock impact bit Phillips - 30 mm length

Specifically made to handle the force from impact drivers and powerfull screwdriver Blue Shock bits have a length of 30 mm. They are designed to give a greater wear resistance and strength than standard bits.



GAMME
VRAC
PAGES 170-171



	TL	Ref.	Gencod	Qty
5 pieces				
PH2	30	U610PH2	3336600172043	1
PH3	30	U610PH3	3336600172067	1
10 pieces				
PH2	30	U610PH210	3336600172050	1
25 pieces				
PH2	30	U610PH225	3336600187634	1

Ref.
U612



Blue-Shock impact bit Pozidriv - 30 mm length

Specifically made to handle the force from impact drivers and powerfull screwdriver Blue Shock bits have a length of 30 mm. They are designed to give a greater wear resistance and strength than standard bits.



GAMME
VRAC
PAGES 170-171



	TL	Ref.	Gencod	Qty
5 pieces				
PZ2	30	U612PZ2	3336600172074	1
PZ3	30	U612PZ3	3336600172098	1
10 pieces				
PZ2	30	U612PZ210	3336600172081	1
25 pieces				
PZ2	30	U612PZ225	3336600187627	1

Ref.
U613



Blue-Shock impact bit Torx - 30 mm length

Specifically made to handle the force from impact drivers and powerfull screwdriver Blue Shock bits have a length of 30 mm. They are designed to give a greater wear resistance and strength than standard bits.



GAMME
VRAC
PAGES 170-171



	TL	Ref.	Gencod	Qty
5 pieces				
T10	30	U613T10	3336600172104	1
T15	30	U613T15	3336600172111	1
T20	30	U613T20	3336600172128	1
T25	30	U613T25	3336600172135	1
T30	30	U613T30	3336600172142	1
T40	30	U613T40	3336600172159	1
25 pieces				
T20	30	U613T2025	3336600189836	1
T25	30	U613T2525	3336600189843	1
T30	30	U613T3025	3336600189850	1

Ref.
U610



Blue-Shock impact bit Phillips - 50 mm length

Specifically made to handle the force from impact drivers and powerfull screwdriver Blue Shock bits have a length of 50 mm. They are designed to give a greater wear resistance and strength than standard bits.



Plastic box



	TL	Ref.	Gencod	Qty
3 pieces				
PH2	50	U610PH2L050	3336600196018	1
PH3	50	U610PH3L050	3336600196025	1

Ref.
U612



Blue-Shock impact bit Phillips - 50 mm length

Specifically made to handle the force from impact drivers and powerfull screwdriver Blue Shock bits have a length of 50 mm. They are designed to give a greater wear resistance and strength than standard bits.



Plastic box



	TL	Ref.	Gencod	Qty
3 pieces				
PZ2	50	U612PZ2L050	3336600196032	1
PZ3	50	U612PZ3L050	3336600196049	1

Ref.
U613



Blue-Shock impact bit Torx - 50 mm length

Specifically made to handle the force from impact drivers and powerfull screwdriver Blue Shock bits have a length of 50 mm. They are designed to give a greater wear resistance and strength than standard bits.



Plastic box



	TL	Ref.	Gencod	Qty
3 pieces				
T10	50	U613T10L050	3336600196094	1
T15	50	U613T15L050	3336600196100	1
T20	50	U613T20L050	3336600196117	1
T25	50	U613T25L050	3336600196124	1
T30	50	U613T30L050	3336600196131	1
T40	50	U613T40L050	3336600196148	1

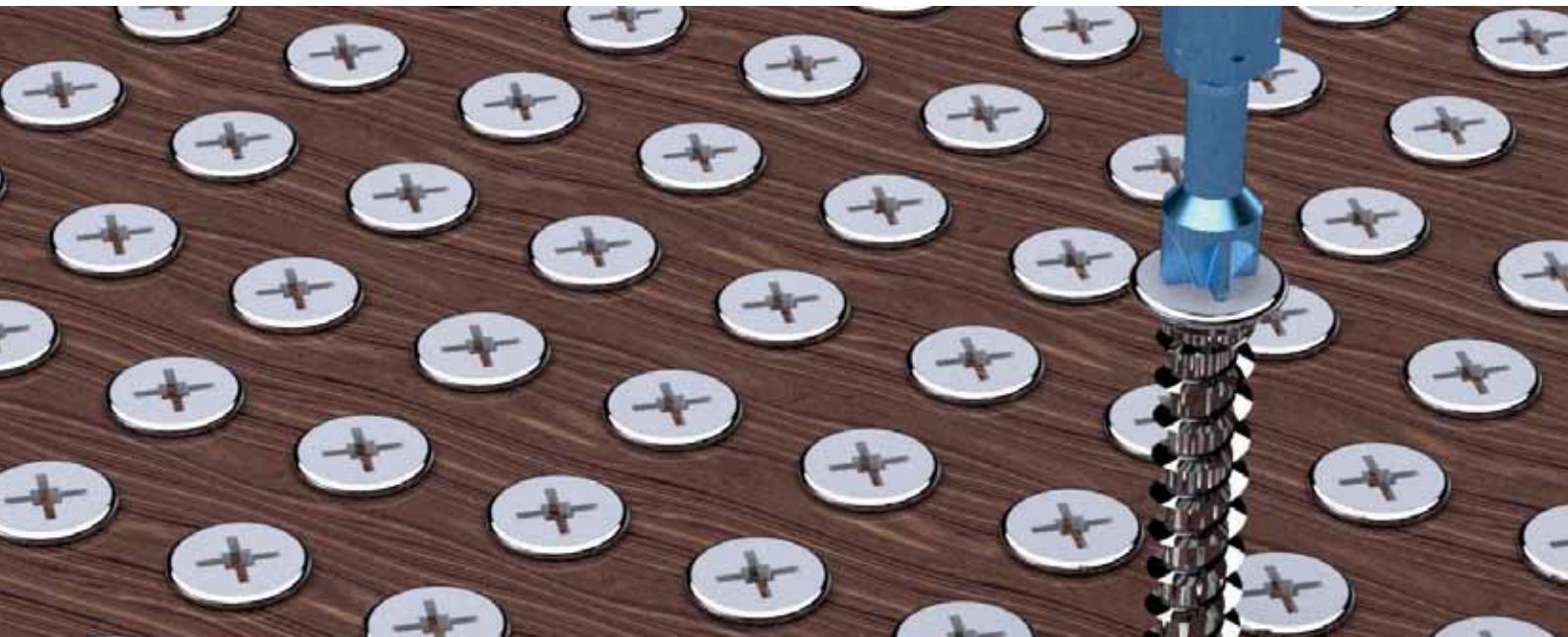

Ref.
U615



Blue-Shock impact bit Hexagonal - 50 mm length

Specifically made to handle the force from impact drivers and powerfull screwdriver Blue Shock.



	TL	Ref.	Gencod	Qty
3 pieces				
HEX3	50	U615HEX03L050	3336600196056	1
HEX4	50	U615HEX04L050	3336600196063	1
HEX5	50	U615HEX05L050	3336600196070	1
HEX6	50	U615HEX06L050	3336600196087	1

Ref.
U617



Blue-Shock impact bit Square - 50 mm length

Specifically made to handle the force from impact drivers and powerfull screwdriver Blue Shock bits have a length of 50 mm. They are designed to give a greater wear resistance and strength than standard bits.



	TL	Ref.	Gencod	Qty
3 pieces				
SQ1	50	U617SQ1L050	3336600195981	1
SQ2	50	U617SQ2L050	3336600196995	1
SQ3	50	U617SQ3L050	3336600196001	1

Ref.
U621B

Blue-Shock bit holder 60 mm

Bit holder specifically made to handle the force from impact drivers and powerfull screwdriver.



TL	Ref.	Gencod	Qty
60	U621B	3336600192379	1

ALL
SETS
PAGES 192-193



631C



641C



U618C



Ref.
U650

Stainless steel bits - length 25 mm

Fasten stainless screws with stainless bits to avoid rust problem.



	TL	Ref.	Gencod	Qty
Phillips - 5 pieces				
PH1	25	U650PH1	3336600189881	1
PH2	25	U650PH2	3336600189898	1
PH3	25	U650PH3	3336600189904	1
Pozidriv - 5 pieces				
PZ2	25	U650PZ2	3336600189928	1
PZ3	25	U650PZ3	3336600189935	1
Torx - 5 pieces				
T10	25	U650T10	3336600189942	1
T15	25	U650T15	3336600189959	1
T20	25	U650T20	3336600189966	1
T25	25	U650T25	3336600189973	1
T30	25	U650T30	3336600189980	1
T40	25	U650T40	3336600190993	1
Plat - 5 pieces				
PL 0.8x5.5	25	U650PL5.5	3336600190023	1
PL 1.2x6.5	25	U650PL6.5	3336600190030	1
PL 0.8x5	25	U650PL5	3336600190016	1

Ref.
U640

Torsion bits 25 & 50 mm for Phillips screws

Torsion bits geometry allows better resistance to high torque and peak loads.

GAMME
VRAC
PAGES 170-171



TORSION
FLEX



	TL	Ref.	Gencod	Qty
L 25 mm - 5 pieces				
PH0	25	U640PH0	3336600186187	1
PH1	25	U640PH1	3336600171909	1
PH2	25	U640PH2	3336600171916	1
PH3	25	U640PH3	3336600171930	1
L 25 mm - 10 pieces				
PH2	25	U640PH210	3336600171923	1
L 25 mm - 25 pieces				
PH1	25	U640PH125	3336600176072	1
PH2	25	U640PH225	3336600189867	1
PH3	25	U640PH325	3336600189874	1



	TL	Ref.	Gencod	Qty
L 50 mm - 5 pieces				
PH1	50	U640PH1L050	3336600172166	1
PH2	50	U640PH2L050	3336600172173	1
PH3	50	U640PH3L050	3336600172197	1
L 50 mm - 10 pieces				
PH2	50	U640PH2L05010	3336600172180	1
L 50 mm - 25 pieces				
PH2	50	U640PH2L05025	3336600176157	1
PH3	50	U640PH3L05025	3336600191594	1

Ref.
U642

Torsion bits 25 & 50 mm for Pozidriv screws

Torsion bits geometry allows better resistance to high torque and peak loads.

GAMME
VRAC
PAGES 170-171



TORSION
FLEX



	TL	Ref.	Gencod	Qty
L 25 mm - 5 pieces				
PZ1	25	U642PZ1	3336600171947	1
PZ2	25	U642PZ2	3336600171954	1
PZ3	25	U642PZ3	3336600171978	1
L 25 mm - 10 pieces				
PZ2	25	U642PZ210	3336600171961	1
L 25 mm - 25 pieces				
PZ1	25	U642PZ125	3336600176096	1
PZ2	25	U642PZ225	3336600187191	1
PZ3	25	U642PZ325	3336600176119	1



	TL	Ref.	Gencod	Qty
L 50 mm - 5 pieces				
PZ1	50	U642PZ1L050	3336600172203	1
PZ2	50	U642PZ2L050	3336600172210	1
PZ3	50	U642PZ3L050	3336600172234	1
L 50 mm - 10 pieces				
PZ2	50	U642PZ2L05010	3336600172227	1
L 50 mm - 25 pieces				
PZ2	50	U642PZ2L05025	3336600176164	1

Ref.
U643

Torsion bits 25 & 50 mm for Torx® screws

Torsion bits geometry allows better resistance to high torque and peak loads.



GAMME
VRAC
PAGES 170-171



**TORSION
FLEX**

	TL	Ref.	Gencod	Qty
L 25 mm - 5 pieces				
T10	25	U643T10	3336600171985	1
T15	25	U643T15	3336600171992	1
T20	25	U643T20	3336600172005	1
T25	25	U643T25	3336600172012	1
T27	25	U643T27	3336600187504	1
T30	25	U643T30	3336600172029	1
T40	25	U643T40	3336600172036	1
L 25 mm - 25 pieces				
T10	25	U643T1025	3336600191624	1
T15	25	U643T1525	3336600191631	1
T20	25	U643T2025	3336600176126	1
T25	25	U643T2525	3336600176133	1
T30	25	U643T3025	3336600176140	1
T40	25	U643T4025	3336600191648	1



Plastic box

	TL	Ref.	Gencod	Qty
L 50 mm - 5 pieces				
T10	50	U643T10L050	3336600172241	1
T15	50	U643T15L050	3336600172258	1
T20	50	U643T20L050	3336600172265	1
T25	50	U643T25L050	3336600172272	1
T30	50	U643T30L050	3336600172289	1
T40	50	U643T40L050	3336600172296	1

Ref.
U641

Torsion bits 25 & 50 mm for Slotted screws

Torsion bits geometry allows better resistance to high torque and peak loads.



**TORSION
FLEX**

	TL	Ref.	Gencod	Qty
L 25 mm - 5 pieces				
PL 0,6x4,5	25	U641PL2	3336600171879	1
PL 0,8x5,5	25	U641PL3	3336600171886	1
PL 1,2x6,5	25	U641PL4	3336600171893	1



Plastic box

	TL	Ref.	Gencod	Qty
L 50 mm - 5 pieces				
PL 0,6x4,5	50	U641PL2L050	3336600181601	1
PL 0,8x5,5	50	U641PL3L050	3336600181618	1
PL 1,2x6,5	50	U641PL4L050	3336600181625	1

ALL
SETS
PAGES 194-195



U642C



U643D

Ref. U620



Phillipps industry bits length 50 to 150 mm with reduced shank

Bits with reduced shank perfect for screwdriving in difficult access.



TL	Ref.	Gencod	Qty
L 50 mm - 5 pieces			
PH0	90 U620PH0L050	3336600186132	1

TL	Ref.	Gencod	Qty
L 70 mm - 3 pieces			
PH1	70 U620PH1L070	3336600181694	1
PH2	70 U620PH2L070	3336600181700	1
PH3	70 U620PH3L070	3336600181717	1

TL	Ref.	Gencod	Qty
L 110 mm - 3 pieces			
PH1	110 U620PH1L110	3336600172371	1
PH2	110 U620PH2L110	3336600172388	1
PH3	110 U620PH3L110	3336600172395	1

TL	Ref.	Gencod	Qty
L 110 mm - 20 pieces			
PH2	110 U620PH2L11020	3336600178465	1



Plastic box

TL	Ref.	Gencod	Qty
L 150 mm - 3 pieces			
PH1	150 U620PH1L150	3336600181724	1
PH2	150 U620PH2L150	3336600181731	1
PH3	150 U620PH3L150	3336600181748	1

Ref. U622



Pozidriv industry bits length 70 to 150 mm with reduced shank

Bits with reduced shank perfect for screwdriving in difficult access.



TL	Ref.	Gencod	Qty
L 70 mm - 3 pieces			
PZ1	70 U622PZ1L070	3336600181755	1
PZ2	70 U622PZ2L070	3336600181762	1
PZ3	70 U622PZ3L070	3336600181779	1

TL	Ref.	Gencod	Qty
L 90 mm - 3 pieces			
PZ1	90 U622PZ1L090	3336600187429	1
PZ2	90 U622PZ2L090	3336600187436	1
PZ3	90 U622PZ3L090	3336600187443	1

TL	Ref.	Gencod	Qty
L 110 mm - 3 pieces			
PZ1	110 U622PZ1L110	3336600172401	1
PZ2	110 U622PZ2L110	3336600172418	1
PZ3	110 U622PZ3L110	3336600172425	1



Plastic box

TL	Ref.	Gencod	Qty
L 150 mm - 3 pieces			
PZ1	150 U622PZ1L150	3336600181786	1
PZ2	150 U622PZ2L150	3336600181793	1
PZ3	150 U622PZ3L150	3336600181809	1

Ref.
U623



Torx® industry bits length 70 to 150 mm with reduced shank

Bits with reduced shank perfect for screwdriving in difficult access.



	TL	Ref.	Gencod	Qty
L 70 mm - 3 pieces				
T10	70	U623T10L070	3336600181816	1
T15	70	U623T15L070	3336600181823	1
T20	70	U623T20L070	3336600181830	1
T25	70	U623T25L070	3336600181847	1
T30	70	U623T30L070	3336600181854	1
T40	70	U623T40L070	3336600181861	1



Plastic box

	TL	Ref.	Gencod	Qty
L 90 mm - 3 pieces				
T10	90	U623T10L090	3336600181878	1
T15	90	U623T15L090	3336600181885	1
T20	90	U623T20L090	3336600181892	1
T25	90	U623T25L090	3336600181908	1
T30	90	U623T30L090	3336600181915	1
T40	90	U623T40L090	3336600181922	1

OR



L150mm : Plastic tube

	TL	Ref.	Gencod	Qty
L 110 mm - 3 pieces				
T25	110	U623T25L110	3336600187450	1
T30	110	U623T30L110	3336600187467	1

	TL	Ref.	Gencod	Qty
L 150 mm - 3 pieces				
T25	150	U623T25L150	3336600187474	1
T30	150	U623T30L150	3336600187481	1

Ref.
U624



Torx® Tamper industry bits length 50 mm with reduced shank

Bits with reduced shank perfect for screwdriving in difficult access.



Plastic box

	TL	Ref.	Gencod	Qty
5 pieces				
TT10	50	U624TT10L050	3336600181939	1
TT15	50	U624TT15L050	3336600181946	1
TT20	50	U624TT20L050	3336600181953	1
TT25	50	U624TT25L050	3336600181960	1
TT30	50	U624TT30L050	3336600181977	1
TT40	50	U624TT40L050	3336600181984	1

Ref.
U625



Hexagonal industry bits length 50 mm with reduced shank

Bits with reduced shank perfect for screwdriving in difficult access.



Plastic box

	TL	Ref.	Gencod	Qty
5 pieces				
HEX2	50	U625HEX02L050	3336600181991	1
HEX2.5	50	U625HEX02.5L050	3336600182004	1
HEX3	50	U625HEX03L050	3336600182011	1
HEX4	50	U625HEX04L050	3336600182028	1
HEX5	50	U625HEX05L050	3336600182035	1
HEX6	50	U625HEX06L050	3336600182042	1
HEX8	50	U625HEX08L050	3336600182059	1

Ref.
U624



Torx® Tamper industry bits length 25 mm
Bits with specifics profiles.



	TL	Ref.	Gencod	Qty
5 pieces				
TT10	25	U624TT10	3336600178472	1
TT15	25	U624TT15	3336600178489	1
TT20	25	U624TT20	3336600178496	1
TT25	25	U624TT25	3336600178502	1
TT30	25	U624TT30	3336600178519	1
TT40	25	U624TT40	3336600178526	1

Ref.
U625



Hexagonal industry bits length 25 mm
Bits with specifics profiles.



	TL	Ref.	Gencod	Qty
5 pieces				
HEX2	25	U625HEX02	3336600176218	1
HEX2.5	25	U625HEX02.5	3336600176225	1
HEX3	25	U625HEX03	3336600176232	1
HEX4	25	U625HEX04	3336600176249	1
HEX5	25	U625HEX05	3336600176256	1
HEX6	25	U625HEX06	3336600176263	1
HEX7	25	U625HEX07	3336600187320	1
HEX8	25	U625HEX08	3336600176270	1

Ref.
U627



Square industry bits length 25 & 50 mm
Bits with specifics profiles.



	TL	Ref.	Gencod	Qty
L. 25 mm - 5 pieces				
SQ0	25	U627SQ0	3336600176171	1
SQ1	25	U627SQ1	3336600176188	1
SQ2	25	U627SQ2	3336600176195	1
SQ3	25	U627SQ3	3336600176201	1
L. 50 mm - 5 pieces				
SQ1	50	U627SQ1L050	3336600193970	1
SQ2	50	U627SQ2L050	3336600187498	1

Ref.
U628



Spanner industry bits length 25 mm
Bits with specifics profiles.



	TL	Ref.	Gencod	Qty
5 pieces				
SP4	25	U628SP4	3336600178533	1
SP6	25	U628SP6	3336600178540	1
SP8	25	U628SP8	3336600178557	1
SP10	25	U628SP10	3336600178564	1

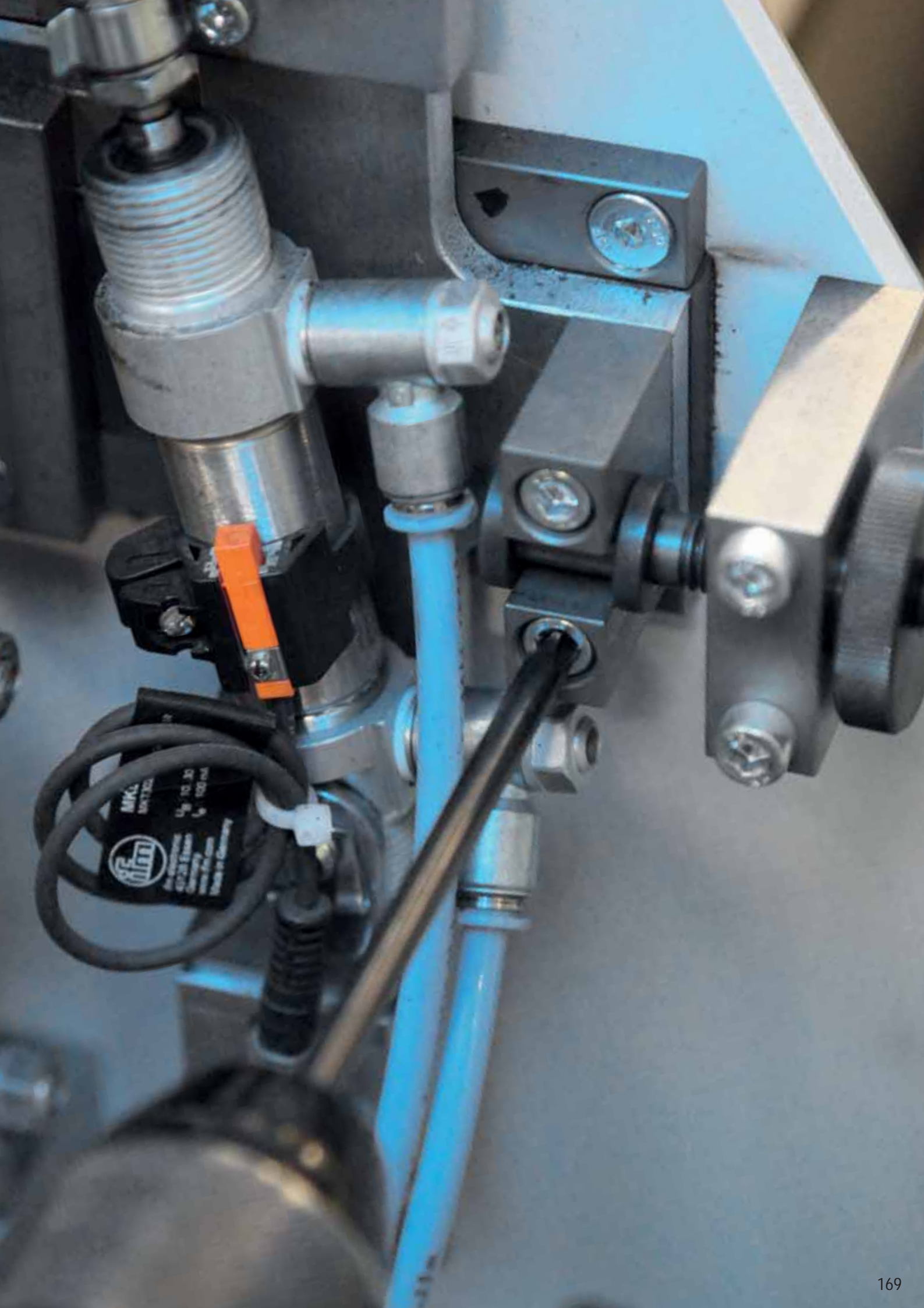

new

SCREW BITS RANGE BULK

Ref.
U610



Blue-Shock impact bit Phillips - 30 mm length

Specifically made to handle the force from impact drivers and powerfull screwdriver Blue Shock bits have a length of 30 mm. They are designed to give a greater wear resistance and strength than standard bits.



	TL	Ref.	Gencod	Qty
100 pieces				
	PH2	30 U610PH2100	3336600203853	1
	PH3	30 U610PH3100	3336600203860	1

Ref.
U612



Blue-Shock impact bit Pozidriv - 30&50 mm length

Specifically made to handle the force from impact drivers and powerfull screwdriver Blue Shock bits have a length of 30 mm. They are designed to give a greater wear resistance and strength



	TL	Ref.	Gencod	Qty
100 pieces				
	PZ2	30 U612PZ2100	3336600203877	1
	PZ3	30 U612PZ3100	3336600203884	1
50 pieces				
	PZ2	50 U612PZ2L05050	3336600203952	1

Ref.
U613



Blue-Shock impact bit Torx - 30 mm length

Specifically made to handle the force from impact drivers and powerfull screwdriver Blue Shock bits have a length of 30 mm. They are designed to give a greater wear resistance and strength than standard bits.

VIDEO TUTO

	TL	Ref.	Gencod	Qty
100 pieces				
	T10	30 U613T10100	3336600203891	1
	T15	30 U613T15100	3336600203907	1
	T20	30 U613T20100	3336600203914	1
	T25	30 U613T25100	3336600203921	1
	T30	30 U613T30100	3336600203938	1
	T40	30 U613T40100	3336600203945	1



Ref.
U640



TORSION FLEX



Embout torsion Phillips - L25 & 50 mm

Embout avec une géométrie torsion, permet d'avoir une meilleure résistance au couple de serrage élevé.



Boîte plastique incolore



Carton



TL	Ref.	Gencod	Qty
L 25 mm - 100 pieces			
PH1	U640PH1100	3336600181564	1
PH3	U640PH3100	3336600181571	1
L 25 mm - 300 pieces			
PH2	U640PH2300	3336600184190	1

TL	Ref.	Gencod	Qty
L 50 mm - 150 pieces			
PH2	50 U640PH2L050150	3336600184299	1

Ref.
U642



TORSION FLEX



Embout torsion Pozidriv - L25 & 50 mm

Embout avec une géométrie torsion, permet d'avoir une meilleure résistance au couple de serrage élevé.



Boîte plastique incolore



Carton



TL	Ref.	Gencod	Qty
L 25 mm - 100 pieces			
PZ1	25 U642PZ1100	3336600178380	1
PZ3	25 U642PZ3100	3336600178403	1
L 25 mm - 300 pieces			
PZ2	25 U642PZ2300	3336600184169	1

TL	Ref.	Gencod	Qty
L 50 mm - 150 pieces			
PZ2	50 U642PZ2L050150	3336600184275	1
PZ3	50 U642PZ3L050150	3336600184282	1

Ref.
U643



TORSION FLEX



Embout torsion Torx® - L25 & 50 mm

Embout avec une géométrie torsion, permet d'avoir une meilleure résistance au couple de serrage élevé.



Boîte plastique incolore



Carton



TL	Ref.	Gencod	Qty
L 25 mm - 300 pieces			
T10	25 U643T10300	3336600184213	1
T15	25 U643T15300	3336600184220	1
T20	25 U643T20300	3336600184237	1
T25	25 U643T25300	3336600184244	1
T30	25 U643T30300	3336600184251	1
T40	25 U643T40300	3336600184268	1

TL	Ref.	Gencod	Qty
L 50 mm - 150 pieces			
T20	50 U643T20L050150	3336600203839	1
T25	50 U643T25L050150	3336600184305	1
T30	50 U643T30L050150	3336600188334	1
T40	50 U643T40L050150	3336600203846	1

Ref.
U628

Magnetic for handling the screws

Magnetic bit holder for easy handling of screws.



Carton



TL	Ref.	Gencod	Qty
90 pieces			
58	U62890	3336600184329	1

BITS HOLDER RANGE

Big & Big Mini

Page 186

Features

- Attachment DIN 3126 E 6,3.
- For hexagonal bits 1/4" according to DIN 3126 C 6,3 et E 6,3.
- Double permanent magnets at the bottom and exit of the bit holder.
- Adjustable system.
- Cold forging process.

Benefits

- Depth adjustable - stop screw function.
- Big compatible with PH2, PH3, PZ2, PZ3, Torx 15 - 30.
- Big Mini compatible with PH1, PZ1 and Torx 10.
- Effective holding of screws with magnets.
- Ideal for long screws.
- Ideal for horizontal and vertical work alike.



DIN 3126 E6,3



DIN 3126 E6,3

Big II

Page 174

Features

- Automatic adjustable magnet.
- Double permanent magnets at the bottom and at the exit of the drill bit holder (ring magnet).
- Quick lock system for all standard bits.
- Cold forging method

Benefits

- Optimal tip hold thanks to powerful magnets.
- Ideal for long bits.
- Ideal for working horizontally and vertically
- Quick ejection and quick replacement of the tip.
- Fast and precise handling even with one hand
- Quick lock attachment for optimal hold in the chuck.



DIN 3126 E6,3



**Made in
GERMANY**

Fox II

Page 186

Features

- Attachment DIN 3126 E 6,3. and compatible SDS+.
- For bits hexagonal 1/4" according to DIN 3126 C 6,3 and E 6,3.
- Permanent magnet.
- Cold forging process.

Benefits

- Quick ejection.
- Very high torsion resistance.
- Quick and easy manipulation with just one hand.
- Magnetic for handling the screws.



DIN 3126 E6,3



Ø10



DIN 3126 E6,3



DIN 3126 E6,3



DIN 3126 E6,3



Ø10

Standard

P. 186-187

Features

- Attachment DIN 3126 E 6,3. and compatible SDS+.
- For hexagonal bits 1/4" according to DIN 3126 C 6,3 and E 6,3.
- Permanent magnet.
- Bit holding ring (except U628).
- Cold forging process.

Benefits

- Magnetic for handling the screws.
- Ideal for hard-to-reach areas, particularly with longer lengths (up to 250 mm).

Ref.
U634

Bits holder BIG for bits PH2-3 PZ2-3 Torx®
n° 15 to 30

Adjustable bits holder with magnetic ring.



Plastic box

TL	Ref.	Gencod	Qty
60	U634	3336600178212	1

Ref.
U639

Bits holder BIG MINI for bits PH1 PZ1 Torx® 10

Adjustable bits holder with magnetic ring.



Plastic box

TL	Ref.	Gencod	Qty
60	U639	3336600181229	1

Ref.
U637

Bits holder BIG II

Porte embout avec double aimant pour un maintien parfait de l'embout (jusqu'à 1 kilos de tenue!). Il possède également une éjection rapide rendant possible son utilisation avec une seule main ainsi qu'une résistance élevée à la torsion.



Boite plastique incolore

TL	Ref.	Gencod	Qty
68	U637	3336600181205	1

Ref.
U648

Bits holder quick-lock Fox II

Quick lock system.



Plastic box

TL	Ref.	Gencod	Qty
60	U648	3336600173156	1

Ref.
U638

Bits holder quick-lock compatible SDS-plus

Quick lock system.



Plastic box

TL	Ref.	Gencod	Qty
80	U638	3336600181212	1

Ref.
627

Stopvis

Stopvis will prevent the screw from passing through the material.



Boite plastique incolore

TL	Ref.	Gencod	Qty
2 pieces			
25	627PH2	3336600146778	1
25	627PZ2	3336600146785	1



Ref.
U626

Standard quick-lock bits holder

Bit holder easy to use with one hand, high torsion resistance and quick-ejection mechanism.



Boite plastique incolore

TL	Ref.	Gencod	Qty
51	U626	3336600189119	1



Ref.
U628

Standard bits holder

Magnetic bit holder allowing to easily manipulate the screws.



Boite plastique incolore

TL	Ref.	Gencod	Qty
58	U628	3336600146792	1



GAMME
VRAC
PAGES 170-171

Ref.
U629

Long standard bits holder

Ideal for difficult to access places especially with long lengths (up to 250mm).



Etui Quality transparent

OU

TL	Ref.	Gencod	Qty
74	U629L074	3336600181243	1
100	U629L100	3336600181250	1
150	U629L150	3336600181267	1
200	U629L200	3336600181274	1
250	U629L250	3336600181281	1



Ref.
U635

Compatible SDS-plus standard bits holder

Magnetic bit holder for easy handling of SDS-Plus compatible screws.



Boite plastique incolore

TL	Ref.	Gencod	Qty
78	U635	3336600178229	1



Ref.
637

90° angle driver

Features

- Suitable for bits or drills 1/4" according to DIN 3126 C6.3 and E6.3.
- Size: 138x50x28.

Benefits

- Very useful to drill in small space.
- High quality and intensive use.

- Can be use with cordless machine.

Advices

- RPM max 2000.



Twistpack

Ref.	Gencod	Qty
637	3336600187580	1

Ref.
644

Bits holder flexible handle

Features

- Attachment E6.3 DIN 3126.
- For bits 1/4" according to DIN 3126 C6.3 and E6.3.
- Total length 270 mm.
- Magnetic bit holder.

Benefits

- Flexible shaft allows bending in any direction.



Black plastic clip

Ref.	Gencod	Qty
644	3336600187511	1



Ref.
645

Quick lock bit holder angle

Features

- Attachment E6.3 DIN 3126.
- For bits 1/4" according to DIN 3126 C6.3 and E6.3.

Benefits

- Ergonomic handle.



Black plastic clip

Ref.	Gencod	Qty
645	3336600190047	1

Ref.
646

Magnetic and telescopic bit holder handle

Features

- Attachment E6.3 DIN 3126.
- For bits 1/4" according to DIN 3126 C6.3 and E6.3.

Benefits

- Adjustable length from 192 to 267 mm with clockwise and anti clockwise rotation.



Blister

Ref.	Gencod	Qty
646	3336600189096	1

Ref.
U601S

Power socket

Surface protection socket

Features

- Attachment E6.3 DIN 3126.
- For hex head screw.

Benefits

- Specially adapted for screws used for fastening

front or sandwich panels and self-drilling screws.



Plastic box

Ø	TL	Ref.	Gencod	Qty
L50				
S07	50	U601S07	3336600181632	1
S08	50	U601S08	3336600181649	1
S10	50	U601S10	3336600181656	1
S1/4 (6,35mm)	50	U601S1/4	3336600181663	1
S5/16 (8mm)	50	U601S5/16	3336600181670	1
S3/8 (9,5mm)	50	U601S3/8	3336600181687	1

Ref.
U600

Pro magnetic socket

Magnetic socket length 50 mm for hexagonal metric screws.

Features

- Attachment E6.3 DIN 3126.
- For hex head screw.

Benefits

- Powerful magnet for holding screws.



Plastic box

Ø	TL	Ref.	Gencod	Qty
L50				
S05.5	50	U600S05.5	3336600187276	1
S06	50	U600S06	3336600173118	1
S07	50	U600S07	3336600172319	1
S08	50	U600S08	3336600172326	1
S09	50	U600S09	3336600190276	1
S10	50	U600S10	3336600172340	1
S12	50	U600S12	3336600172357	1
S13	50	U600S13	3336600172364	1
S1/4 (6:35mm)	50	U600S1/4	3336600172302	1
S5/16 (8mm)	50	U600S5/16	3336600192393	1
S3/8 (9,5mm)	50	U600S3/8	3336600192386	1

Ref.
U603

Pro magnetic socket

Magnetic socket length 65 mm for hexagonal metric screws.



Plastic box

Ø	TL	Ref.	Gencod	Qty
L65				
S05	65	U603S05	3336600187368	1
S05.5	65	U603S05.5	3336600187375	1
S06	65	U603S06	3336600187382	1
S07	65	U603S07	3336600187399	1
S08	65	U603S08	3336600187283	1
S10	65	U603S10	3336600187290	1
S12	65	U603S12	3336600190283	1
S13	65	U603S13	3336600187313	1

Features

- Attachment E6.3 DIN 3126.
- For hex head screw.

SCREWDRIVING



Features	Pcs	Composition	Ref.	Gencod
BLUE SHOCK BIT	7	PZ2-3 / T20-25-30-40 + 1 standard bit holder 58 mm	U618C	3336600190290
BLUE SHOCK BIT	10	PZ2(x2)-PZ3 / TX15-20(x2)-25(x2)-30 + 1 special impact screwdriver bit holder	631C	3336600194113
BLUE SHOCK BIT	8	PZ2(x2)-PZ3 / PH2(x2) PH3 / TX20-26	641C	3336600196544
TORSION BIT	38	PH 1-2(x2)-3(x2)/PZ 1-2(x2)-3(x2)/TX 10-15-20(x2)-25(x2)-30-40/PL 0.6X4.5-0.8X5.5-1.2X6.5/HEX4-5 -10 sockets : 5-6-7-8-9-10-11-12-13-14 + Extension 50 and 100 mm + 1 universal adapter + 1 adapter 1/4" + 1 screwdriver ratchet + 1 hand screwdriver	6000A	3336600199866
TORSION BIT	46	PZ 1(x2)-2(x3)-3(x2)/PL 0.6X4.5-0.8X5.5-1.2X6.5/ PH 1(x2)-2(x3)-3(x2)/HEX3-4-5/TX 10-15(x2)-20(x2)-25(x2)-27-30-40/HEX3-4-5-6-8 - 10 sockets : 5-6-7-8-9-10-11-12-13-14 + 1 STD bit holder 51mm + 1 adapter 1/4" + 1 screwdriver ratchet + 1 hand screwdriver	6000B	3336600199873
TORSION BIT	36	PZ 2(x2)-3/PH 2(x2)-3/TX 15-20-25-30/HEX6-8 - L50 mm : PZ 2(x2)-3/PH 2(x2)-3/TX 15-20-25-30 - 10 douilles : 5-6-7-8-9-10-11-12-13-14 + 1 STD bit holder 51 mm + 1 adapter 1/4" + 1 screwdriver ratchet + 1 hand screwdriver	6000C	3336600202139





635C



632C



633C



636C



634C

Features	Pcs	Composition	Ref.	Gencod
TORSION BIT	8	L50 mm: PZ 1 / PZ 2 (x2) PH 2 (x2) / PH 3 / Tx 20 / Tx 26	636C	3336600194847
TORSION BIT	38	L25 mm: PZ 1-2(x3)-3-(x2) / PH 1-2(x3)-3(x2) / PL 4,5-5,5/ HEX 2-3-4-5 TX 10-15-20(x2)-25(x2)-30(x2)-40 / SQ 1-2-3 - 50 mm: PZ1-2/PH2-3/TX20-25-30 + 1 Bit holder	632C	3336600194120
TORSION BIT	32	L25 mm: PZ1(x2)-2(x3)-3(x2)/PH1(x2)-2(x3)-3(x2)/PL4,5-5,5/TX10-15-20(x3)-25(x2)-30(x2)-40/HEX2-3-4-5-6 + 1 bit holder standard	634C	3336600197367
TORSION BIT	32	L25 mm: PZ1(x2)-2(x3)-3(x2)/PH1(x2)-2(x3)-3(x2)/PL4,5-5,5/TX10-15-20(x3)-25(x2)-30(x2)-40/HEX2-3-4-5-6 + 1 bit holder FOX II	635C	3336600194106
TORSION BIT	28	L25 mm: PZ 1-2(x2)-3(x2)/PH1-2(x2)-3(x2)/TX15-20(x2)-25(x2)-30-40/HEX 3-4 - Ratchet: 1/4" - sockets: 5,5/7 / 8 / 10 / 11 / 12 /13 + 1 socket holder(6,35 mm)	633C	3336600194137



SCREWDRIVING



U601



U602



U649C



U642C



U642D



U641D

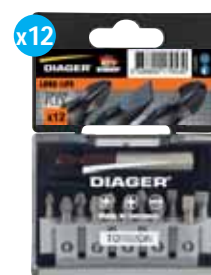

U640D

Features	Pcs	Composition	Ref.	Gencod
SURFACE PROTECTION SOCKET	7	SW 7-8(x2)-3/8-10(x2)-5/17	U601	3336600189102
PRO MAGNETIC SOCKET	7	HEX 1/4-7-8-3/8-10-12-13 - L 50 mm	U602	3336600187115
TORSION BIT	7	PZ1-2-3/PH1-2-3 + Bit holder	U641D	3336600179530
TORSION BIT	7	TX10-15-20-25-30-40 + Bit holder	U642C	3336600179547
TORSION BIT	12	PZ1-2 (2)-3/PH1-2 (2)-3/ TX15-20-25 + Bit holder	U642D	3336600180642
TORSION BIT	12	PZ1-2 (2)-3/PH1-2 (2)-3/ PL4,5-5,5-6,5 + Bit holder	U640D	3336600179523
TORSION BIT	15	PZ 1-2(2)-3 PH 1-2(2)-3 TX 15-20-25-30 PL5,5-6,5 + 1 Quick Lock bit holder FOX II	U649C	3336600183001





x45

U644C



x80

U643D



Features	Pcs	Composition	Ref.	Gencod
TORSION BIT	45	PH 1-1-2-2-3-3/PZ 1-1-2-2-3-3/PL 0.5X3 - 0.6X4.5 - 0.8X5.5 - 1X5.5 - 1.2X6.5 - 1.6X8/HX 2.5-3-4-5-6-7/ TX 10-15-20-25-30-40 - 10 Sockets: 5-6-7-8-9-10-11-12-13-14 + 1 screwdriver ratchet + bit holder Fox II + 1 hand screwdriver + 1/4" female square adaptor on 1/4" hexagon - 1/4" square adaptor on hexagon	U644C	3336600182073
TORSION BIT	80	1 magnetic holder FoX II + 1 hand screwdriver with 8 embouts (Ph1, Ph2, Pz1, Pz2, TorxT15, T20, T25, T30) 70 «Industry» bit each Torsion: SL 0.5x3.0-0.6x4.5-0.8x5.5(x2)-1.2x6.5-1.6x8.0/PH 0-1-2(x4)-3(x2)/ HEX 2.0-2.5-3.0-4.0-5.0-6.0-7.0-8.0/PZ 1-2(x4)-3(x2)/TW 1-2-3-4-5/TQS 5-6-8-10/SQ 0-1-2-3/Tx Ta 10-15-20-25-30-40/HEXTa 3.0-4.0-5.0-6.0/Spanner 4-6-8-10/Tx 05-06-07-08-09/Tx 10-15-20(x2)-25(x2)-27-30-40	U643D	3336600182066



SCREW BITS MERCHANDISING

MODULAR CONCEPT

A minimum of space for a maximum
of references



Features	Ref.	Gencod
1M SALES SHELF (to attribute with the pediment of your choice)	GOND1000	3336609000019
0,5M SALES SHELF (to attribute with the pediment of your choice)	GOND500	3336609000071
DIAGER LUMINAR PEDIMENT FOR 1M SALES SHELF	M00202	3336609009500
DIAGER LUMINAR PEDIMENT FOR GOND500	M00203	3336609009975
ELECTRIC CABLE FOR LUMINAR PEDIMENT (to attribute with each command of pediment)	CORDON	3336600187528
DIAGER PEDIMENT FOR GOND1000/1	FR1000	3336609005472
DIAGER PEDIMENT FOR GOND500	FR500	3336609005373
ADJUSTABLE RACK WITHOUT HOOKS 1M	M00150	3336609004468
ADJUSTABLE RACK WITHOUT HOOKS 0,5M	M00158	3336609005793
DOUBLE HOOK	M00151	3336609004475
SIMPLE HOOK	M00152	3336609004482
ANTI-THEFT 1M	ANTIVOL1000	3336609002037
ANTI-THEFT 0,5M	ANTIVOL500	3336609004291
ANTI-THEFT FOR HOOKS	M00169	3336609006745
SHELF 900 MM ADJUSTABLE WIDTH DEPTH 360 MM	M00167	3336609006141
SHELF 500 MM ADJUSTABLE WIDTH, DEPTH 400 MM	TAB500400	3336609000170
DISPLAY CASE (to attribute with 1 BAR1000)	M00157	3336609005274
1M STAY FOR 1M SALES SHELF	BAR1000	3336609000057
0,5M STAY FOR 0,5M SALES SHELF	BAR500	3336609000095
MONOBLOC DISPLAY	M00171	3336609006844
PR24 DISPLAY - STRUCTURE ONLY (delivered flat)	M00135	3336609007643
6 HOOKS RACK (with label holder)	M00101	3336609008640
BULK DISPLAY FOR SCREW BITS	M00120	3336609001306
POS COUNTER (DELIVERED WITH 2 SHELVES)	C00085	3336609005397
HOOK FOR REF.C00085	C00087	3336609005670
DISPLAY COUNTER FOR BIT HOLDERS (24PCS)	U3016418	4013769421968
IOP SHELF TALKER BLUESHOCK	B00448	3336609006155
TWIN STICK	M00075	3336600196964
SCREW BITS MAGNET	B00402	3336609004413
SCREWING GUIDE MAGNET	B00403	3336609004420



BULK DISPLAY

Bulk bits storage system.
Ref. M00120



DISPLAY BIT HOLDERS

POS counter for bit holders
Range recommended or adapted according to your needs



1 METER DISPLAY

Screw bits display

Rack Presentation

Color-segmented screwing range for each family (Torsion, Impact, Diatin, Quality, Bit Holders and Sockets).

Declinations on 1M Sales shelf



PROMOTION

Modular counter concept



DIAGER®

HOLE SAWS RANGE



HSS HOLE SAWS



■ TEETH MILLED

Milled teeth (compared to cut teeth) show more strength in metal and have a longer life.

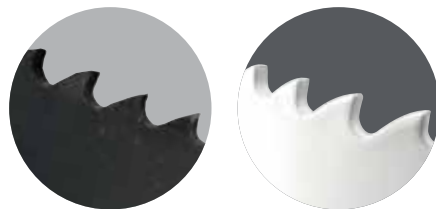

■ TEETH SIDE SET

Setting directs one tooth to the left and another to the right. That is crucial to give the saw high cutting power, and it also makes the removal of cut particles easier, keeping the saw from blocking while sawing.

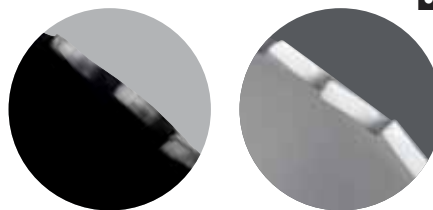

■ PROGRESSIVE TEETH

Set of seven teeth with well-defined shapes, reproduced over the whole perimeter of the saw. Variable-pitch teeth for cutting versatility with definite materials (metal, wood, plastics etc.), reducing vibrations and allowing a better finish.

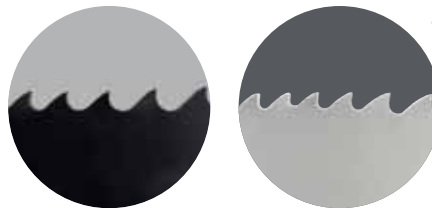

■ TEETH 8% COBALT

The addition of cobalt improves resistance to heat. That alloy element makes it possible to withstand greater cutting forces and drill hard materials such as stainless steel. The life is longer than that of a standard HSS saw.





Ref.
650

Hole saw

Bi-metal HSS 8% cobalt

Bimetal Hole Saw 8% cobalt provides better resistance in drilling hard steels such as stainless steel. Variable toothing enable clean and fast cut.



- HSS 8% COBALT
- VERSALITY

Features

- Teeth HSS 8% cobalt.
- Teeth milled and site set.
- Variable toothing 4-6 tpi.

Benefits

- High resistance.
- Longlife.
- Clean and fast cut.

Applications

- Precise holes for electrical sockets, cables, tubes.



Stainless steel, Composite, Alloy steel, Low density wood, Cast iron

HSS-E
8 % Co

Ø	WL	TL	Ref.	Gencod	Qty	Ø	WL	TL	Ref.	Gencod	Qty
14	36	54	650D14	3336600159266	1	64	38	43.5	650D64	3336600159570	1
16	36	54	650D16	3336600159273	1	65	38	43.5	650D65	3336600159587	1
17	36	54	650D17	3336600159280	1	67	38	43.5	650D67	3336600159594	1
19	36	51	650D19	3336600159297	1	68	38	43.5	650D68	3336600159600	1
20	36	51	650D20	3336600159303	1	70	38	43.5	650D70	3336600159617	1
21	36	51	650D21	3336600159310	1	73	38	43.5	650D73	3336600159624	1
22	36	51	650D22	3336600159327	1	76	38	43.5	650D76	3336600159631	1
23	36	51	650D23	3336600159334	1	79	38	43.5	650D79	3336600159648	1
24	36	51	650D24	3336600159341	1	83	38	43.5	650D83	3336600159655	1
25	36	51	650D25	3336600159358	1	86	38	43.5	650D86	3336600159662	1
27	36	51	650D27	3336600159365	1	89	38	43.5	650D89	3336600159679	1
29	36	51	650D29	3336600159372	1	92	38	43.5	650D92	3336600159686	1
30	36	51	650D30	3336600159389	1	95	38	43.5	650D95	3336600159693	1
32	36	49	650D32	3336600159396	1	98	38	43.5	650D98	3336600159709	1
33	36	49	650D33	3336600159402	1	102	38	43.5	650D102	3336600159716	1
35	36	49	650D35	3336600159419	1	105	38	43.5	650D105	3336600159723	1
37	38	43.5	650D37	3336600159426	1	108	38	43.5	650D108	3336600159730	1
38	38	43.5	650D38	3336600159433	1	111	38	43.5	650D111	3336600159747	1
40	38	43.5	650D40	3336600159440	1	114	38	43.5	650D114	3336600159754	1
41	38	43.5	650D41	3336600159457	1	121	38	43.5	650D121	3336600159761	1
43	38	43.5	650D43	3336600159464	1	127	38	43.5	650D127	3336600159778	1
44	38	43.5	650D44	3336600159471	1	133	38	43.5	650D133	3336600159785	1
46	38	43.5	650D46	3336600159488	1	140	38	43.5	650D140	3336600159792	1
48	38	43.5	650D48	3336600159495	1	146	38	43.5	650D146	3336600159808	1
51	38	43.5	650D51	3336600159501	1	152	38	43.5	650D152	3336600159815	1
52	38	43.5	650D52	3336600159518	1	160	38	43.5	650D160	3336600159822	1
54	38	43.5	650D54	3336600159525	1	168	38	43.5	650D168	3336600159839	1
57	38	43.5	650D57	3336600159532	1	177	38	43.5	650D177	3336600159846	1
58	38	43.5	650D58	3336600159549	1	200	38	43.5	650D200	3336600159853	1
59	38	43.5	650D59	3336600159556	1	210	38	43.5	650D210	3336600159860	1
60	38	43.5	650D60	3336600159563	1						



new Ref. 654

Scie-cloche Bi-métal

DISPONIBLE DÈS
MARS 2023



Scie cloche bi-métal idéale pour percer les matériaux tendres occasionnant d'importants copeaux lors de leur coupe (bois, plâtre). Dotées d'importantes fentes de dégagement pour faciliter les évacuations lors des percements mais également pour l'extraction de la carotte.



• RAPIDITÉ

Description

- Denture HSS.
- Denture fraisée et avoyée.
- Denture progressive.
- Profondeur de coupe 45mm.
- Larges fentes de dégagement.
- 4-6 tpi/mm.

Avantages

- Durée de vie.
- Perçage rapide
- Dégagement maximal des copeaux grâce aux fentes larges.
- Facilité d'extraction de la carotte.
- Finitions propres.



Bois tendre, Aggloméré, Plaque de plâtre, PVC

HSS

Ø	WL	TL	Ref.	Gencod	Qty
20	45	55	654D20	3336600206052	1
22	45	55	654D22	3336600205932	1
25	45	55	654D25	3336600205949	1
32	45	50	654D32	3336600205956	1
35	45	50	654D35	3336600205963	1
40	45	50	654D40	3336600205970	1
44	45	50	654D44	3336600205987	1
51	45	50	654D51	3336600205994	1
60	45	50	654D60	3336600206069	1
68	45	50	654D68	3336600206007	1
70	45	50	654D70	3336600206076	1
76	45	50	654D76	3336600206014	1
83	45	50	654D83	3336600206021	1
102	45	50	654D102	3336600206038	1
127	45	50	654D127	3336600206083	1



Clip noir



Scie cloche
651C

VIDEO TUTO



Standard system

HEXAGONAL

Ref. 651HEX01 Arbor for hole saw 14-30 mm hexagonal shank 9,5 mm with HSS pilot drill bit



Tube Srewpack



TL	Ref.	Gencod	Qty
100	651HEX01	3336600159877	1

Ref. 651HEX03 Arbor for hole saw 32-210 mm hexagonal shank 9,5 mm with HSS pilot drill bit



Tube Srewpack



TL	Ref.	Gencod	Qty
127	651HEX03	3336600159891	1

Standard System



Ref. 651HEX01



Réf. 651L

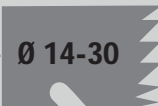

Ø 14-30

Ref. 651HEX03



Réf. 651L



Ø 32-210

Ref. 651RA Hole saw extension 300 mm hexagonal shank 9,5 mm



Tube DIY



TL	Ref.	Gencod	Qty
300	651RAHEXL300	3336600192584	1

Ref. 651L 2 HSS pilot drill bit 83 mm for hexagonal hole saw arbor



Tube DIY



Pilote compatible	TL	Ref.	Gencod	Qty
651HEX01 - 651HEX03	83	651L083	3336600159938	1
Quick lock 652QLHEX	102	651L102	3336600159945	1

Quick Lock system

HEXAGONAL

Ref. 652QLHEX Quick lock arbor hex shank
 Pilote attachement hexagonal 11 mm avec système quick lock.
 Compatible avec le foret centreur réf 651L102.



TL	Ref.	Gencod	Qty
127	652QLHEX	3336600159952	1

Ref. 652QLDF 5 adapter double thread for quick lock hole saw arbor



Ref.	Gencod	Qty
652QLDF	3336600160002	1



Système Quick Lock

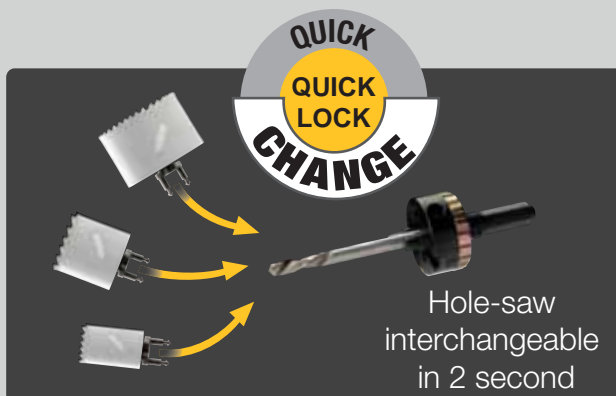
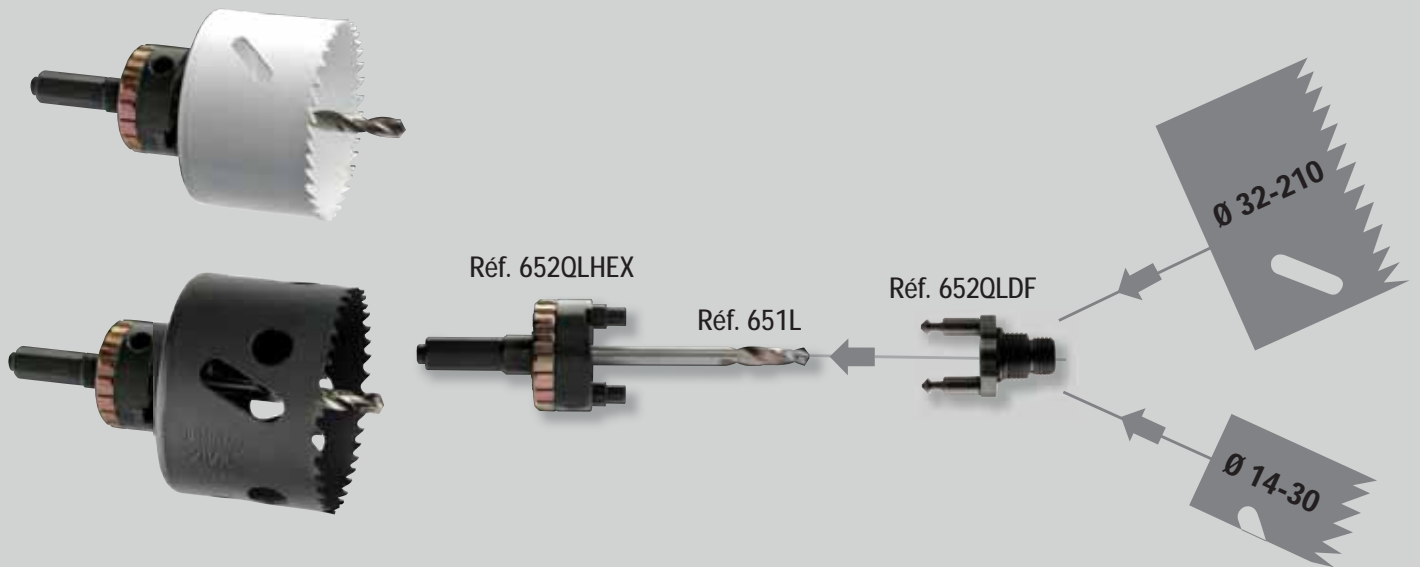

HOLE SAW SETS



General
655C



Plumber
653C



General
Quick-Lock
656C

Features	Pcs	Composition	Ref.	Gencod
KIT	1	Holesaw Ø68 mm	650BD68	3336600195400
PLUMBER HOLESAW SET	9	Ø19-25-32-38-44-57-68 mm + 2 pilots hexagonal 9.5 mm with centering drill bit (Ø14-30 / Ø32-210 mm)	653C	3336600160316
ELECTRICIAN HOLESAW SET I	8	Ø22-35-51-57-68-76 mm + 2 pilots hexagonal 9.5 mm with centering drill bit (Ø14-30 / Ø32-210 mm)	654C	3336600160323
ELECTRICIAN HOLESAW SET II	8	Ø22-40-54-65-68-73 mm + 2 adapters hexagonal with centering drill bit	657C	3336600173866





Electrician I
654C



Electrician II
657C



Kit
650BD68



General Quick-Lock
651E

Features	Pcs	Composition	Ref.	Gencod
GENERAL HOLESAW SET	12	Ø19-22-25-32-35-38-44-57-68-76 mm + 2 pilots hexagonal 9.5 mm with centering drill bit (Ø14-30 / Ø32-210 mm)	655C	3336600160330
GENERAL QUICK-LOCK HOLESAW SET	20	Ø19-22-25-32-38-44-57-68-76 mm + 1 pilot quick-lock hexagonal 9.5 mm with centering drill bit + 10 connectors	656C	3336600167001
GENERAL QUICK-LOCK HOLESAW SET	5	Ø83-102 mm 1 adapter quick-lock with centering drill bit + 2 connectors	651E	3336600185968



SCIAGE MADE IN GERMANY



JIGSAW, RECIPROCATING SAW

Product characteristics

STAR teeth

Conically ground blade, teeth triply sharpened.

Benefits: Extreme fast, precise and clean cuts in all woods and plastics.

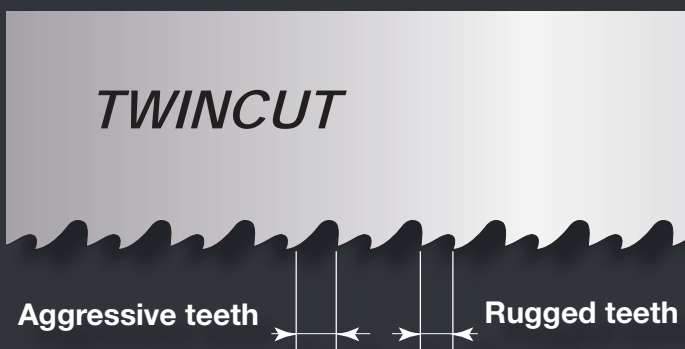

TWINCUT teeth

Ideally applicable for metal sheets treatment, pipes and profiles with a thickness over 2 mm and dismantling of wood with nails/screws. The perfect twins: robust and aggressive and twin-cut toothing. There is a continuous change between a **very aggressive tooth** with a deep chip space and a **very robust tooth** with a flat chip space thus allowing a maximum speed and stability.

XLS technology: TWIN-CUT reciprocating saw blades are manufactured from a new powder metallurgical high-performance steel. The physical features of this XLS material make essentially smoother structures at the cutting edges of the teeth in the micro range.

With the XLS technology feature: **thougher hardness treatment, better heat resistance, sharper longer.**



CHOICE OF TEETH / APPLICATION

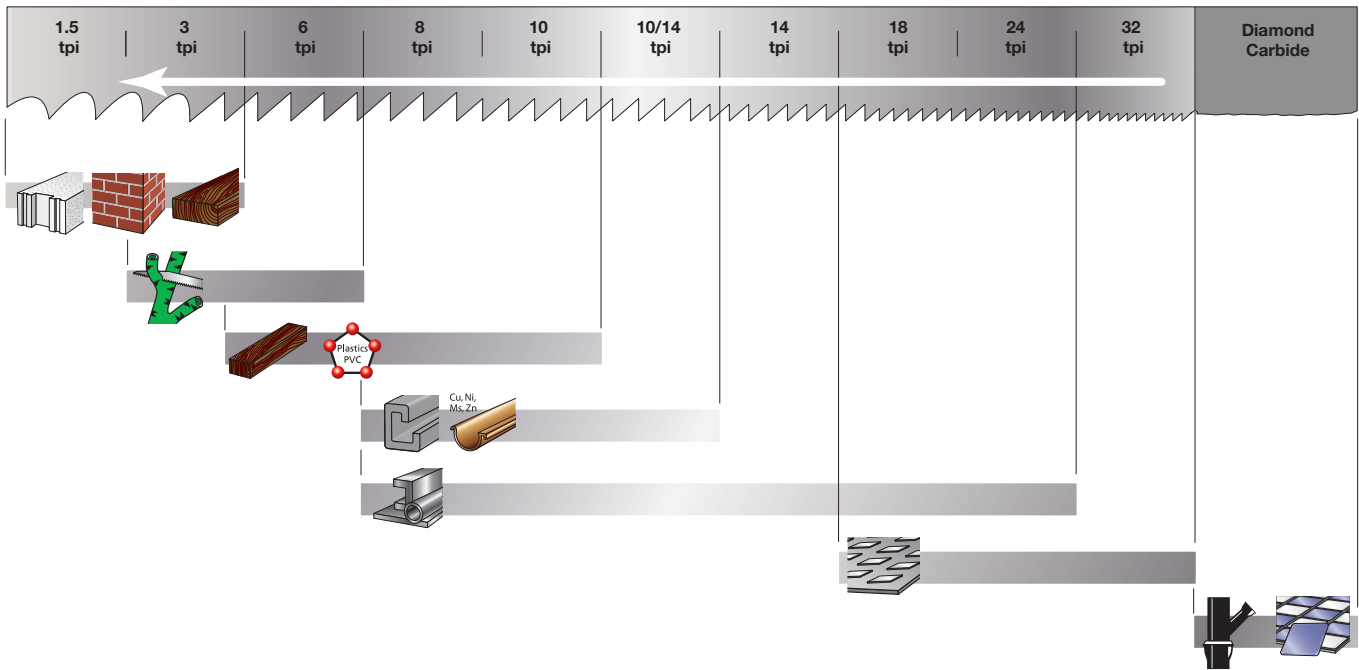

CHOICE OF BLADE MATERIAL / APPLICATION

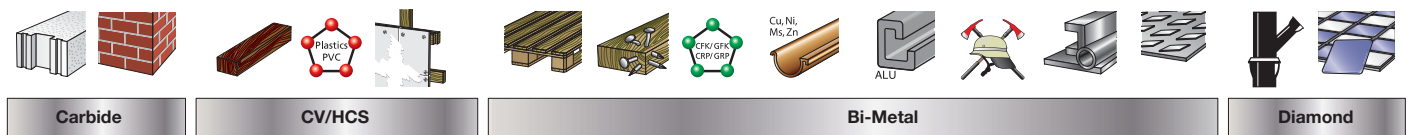

CHOICE OF SAW LENGTH

Blade length: material thickness + 50 mm

Always keep 2 or 3 teeth in the material.

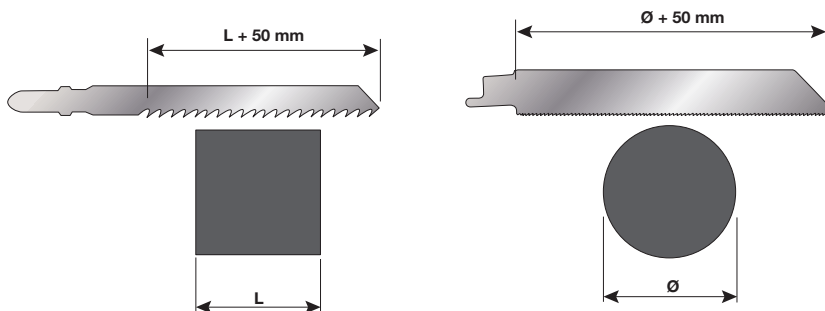

GLOSSARY PICTOGRAM

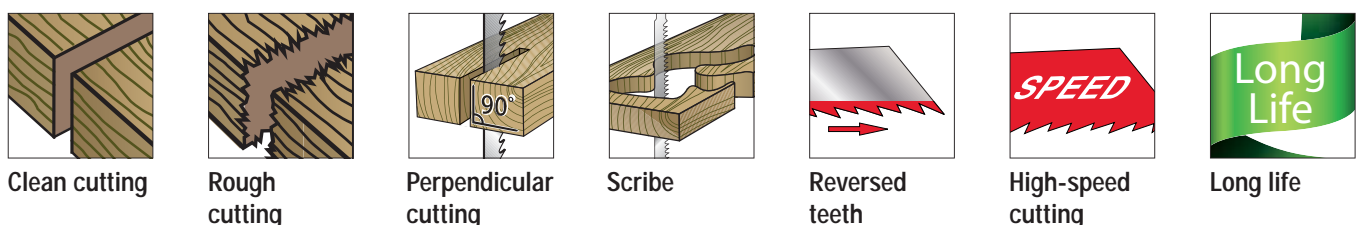

KIND OF TOOTHING

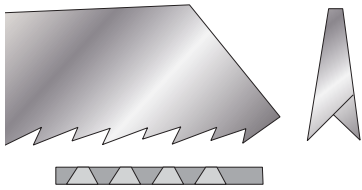

Grinded (or sharpened) teeth,
conically ground blade.

FAST CUT AND CLEAN

- The perfect aligned teeth allows a fast, precise and straight cut.
- The conical body of the blade leaves a gap between material and blade. Because of the gap, the chips get off and the blade cuts fast.

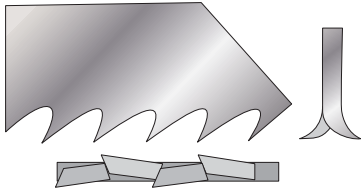

Grinded (or sharpened) and
side set teeth.

FAST AND ROUGH CUT

- The sharpened teeth cut the wood fibres that warranties a high speed cut especially adapted to wood cutting.

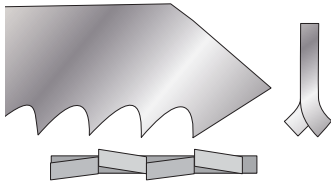

Milled and side set teeth.

FAST AND ROUGH CUT

- The milled and side set teeth cut roughly with high speed in wood, aluminium, non-ferrous metals and plastics.

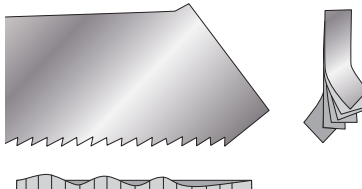

Milled and wavy set teeth.

CLEAN AND THIN CUT

- The milled and wavy set teeth keep contact with the material to cut, avoiding jerks and allowing thin and straight cut in thin material boards.

TEETH DIRECTION

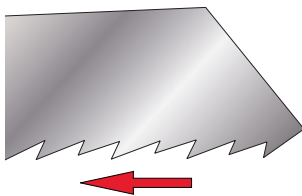

Regular tootinging
On Pull

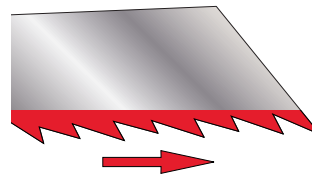

Reverse tootinging
On Push
Very clean and splinter-
proof surface cut

DOUBLE TEETH



Ideal for curved cutting

TYPES OF SAW



HSS

High quality high-speed steel. Allows high-speed cutting. Offers **high resistance to wear**. Designed for **hard materials**.

HCS CV

Steel alloy with carbon, chromium and vanadium. Chromium offers greater **corrosion resistance**. Vanadium increases the **heating capacity**. Designed for **soft materials**.

CARBIDE

CARBIDE

There are three types of carbide saws : carbide-encrusted saws, saws with added carbide teeth or saws with added carbide strips. Carbide blades show **high performance and make it possible to cut hard and/or abrasive materials**.

DIAM

The DIAM blades are diamond gritted. These blades especially suit very **hard and/or abrasive materials** like composite materials.

Bi Metal FLEX

Bimetal refers to an item made of an assembly of two distinct types of steel, as opposed to alloys. The structure gives saw blades the best combination of cutting speed and durability, because the benefits of each type of steel are used where they are valuable : **the teeth are harder and offer high cutting performance, and the blade is more flexible, harder to break and stronger**. The life of bimetal saws is twice to ten times that of HSS or HCS blades.

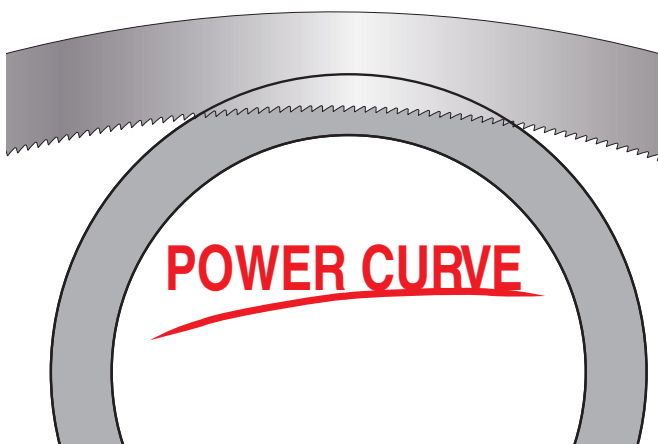

The latest design of a curved blade shape perfectly supports the natural orbital movement of the reciprocating saws thus allowing a high power transmission. Likewise the teeth are cutting into the work piece with the best angle possible based on the curved blade. They saw more effectively and thus achieve a better removal of the splints and a slower wearing down. You can perfectly utilize the length of the blade: there are up to additionally 10% of the teeth cutting into the work piece compared to a straight blade of the same length.

Benefits:

Faster working: cutting speed increased by up to 30%, more cuts: longer lifetime up to 25% compared to those blades with a straight shape.

BRANDS SAW BLADES COMPATIBILITY

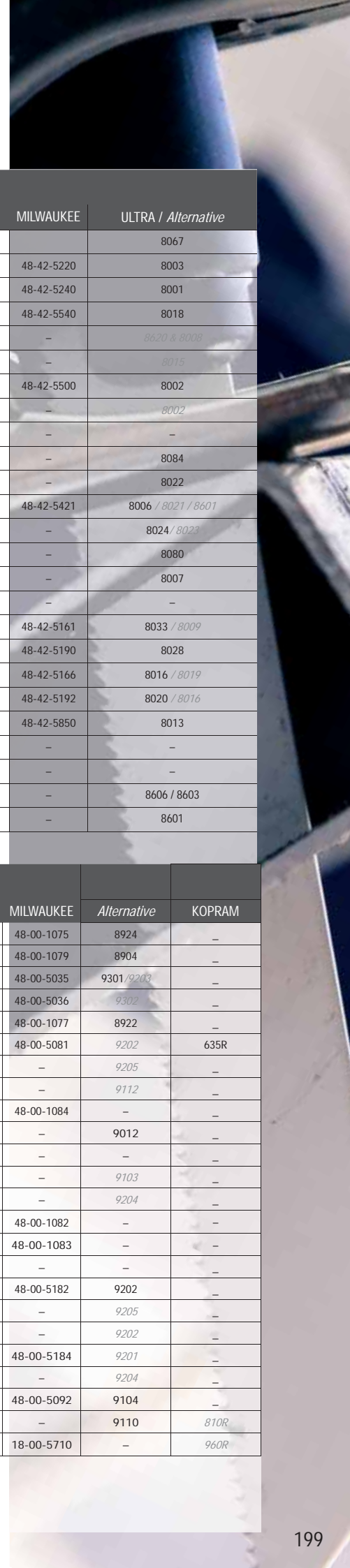

JIGSAW BLADES

DIAGER	AEG	BOSCH / Alternative	FESTOOL	LENOX	MAKITA	METABO	MILWAUKEE	ULTRA / Alternative
L000W5	373083	T101AIF / T101AOF & T101BIF	-	-	P31566	23948	-	8067
L001W5	254071	T111C / T119B	-	410S	B13/A85656	23632	48-42-5220	8003
L002W5	254061	T101B	S75/2,5	450S	B11/A85634	23634	48-42-5240	8001
L003W5	346079	T101BR	-	450SR	B19/A85715	23650	48-42-5540	8018
L004W5	-	T101BF & T101BRF	HS75/3 BI FC	-	-	-	-	8620 & 8008
L005W5	-	T119B0	-	-	-	-	-	8015
L006W5	274351	T101D	-	456S	B12/A85640	23635	48-42-5500	8002
L007W5	373080	T101DP	575/4FS	-	-	23655	-	8002
L008W5	-	T308B	-	-	-	-	-	-
L012W5	-	T234X / T102BF BIM	-	-	-	23675	-	8084
L009W5	399306	T301CD	-	-	B10/A85628	23654	-	8022
L010WL1005	213116	T144D / T144DF & T144DP & T244D	S75/4	406S	B16/A85684	23633	48-42-5421	8006 / 8021 / 8601
L010WL1325	311633	T344D / T344DF	S105/4	-	L2/P06454	23678	-	8024 / 8023
L010WL1805	354745	T744D	-	686S	A86315	23603	-	8080
L011W5	265312	T 244 D	-	-	P31572	-	-	8007
L012S5	-	T123XF / T123X & T345X & T345XF	-	-	-	-	-	-
L000M5	340011	T118AF / T118A & T218A	HS60/1,2BI	318S/324S	P47226	23971	48-42-5161	8033 / 8009
L001M5	340012	T118BF / T101A & T118B	HS60/2bi	314S	P47232	23973	48-42-5190	8028
L002M5	274654	T318AF	HS105/1,2BI	518S	P47204	23978	48-42-5166	8016 / 8019
L003M5	274653	T318BF	HS105/2bi	-	P47210	23979	48-42-5192	8020 / 8016
L004M5	340014	T127D & T227D	HS75/3bi	-	-	23974	48-42-5850	8013
L005M2	373393	T118AHM / T118EHM	-	-	P-05929	23662	-	-
LMX001	-	T345XF	-	-	-	-	-	-
L100W5	-	-	-	-	-	-	-	8606 / 8603
L101W5	-	-	-	-	-	-	-	8601

RECIPROCATING SAW BLADES

DIAGER	AEG	BOSCH / Alternative	DEWALT	LENOX	MAKITA	METABO	MILWAUKEE	Alternative	KOPRAM
L200WL1505	323800	S644D	DW4802	656R	P47086	37470	48-00-1075	8924	-
L200WL3005	323802	S1344D / S1111DF	DW4804	156R	P05016	31472	48-00-1079	8904	-
L201WL1505	354775	S611DF / S641HM & S611VF & S611DF	-	656R	P05088	-	48-00-5035	9301 / 9203	-
L201WL2255	354777	S1111DF	-	956R	-	-	48-00-5036	9302	-
L202WL2405	323803	S1531L / S1617K & S1111K	-	-	P47117	31488	48-00-1077	8922	-
L204SL1505	-	S922VF	DW4845	650R	P47014	31492	48-00-5081	9202	635R
L204SL2255	373288	S1122VF / S1120CF & S1122HF	-	-	-	31495	-	9205	-
L204SL2805	-	S1222VF	-	110R	-	31407	-	9112	-
L200SL3002	-	S 713 A	-	-	P80444	-	48-00-1084	-	-
L201SL2001	-	-	-	800RDG	-	-	-	9012	-
L202SL1152	-	S518EHM	-	-	-	31817	-	-	-
L203SL1505	-	-	-	-	-	-	-	9103	-
L203SL2255	-	S1234XF	-	-	-	-	-	9204	-
L205SL3001	373027	S1211K	-	-	-	-	48-00-1082	-	-
L205SL4001	373028	-	-	-	-	-	48-00-1083	-	-
L206SL3001	-	-	-	-	-	-	-	-	-
L200ML1505	354789	S922BF	DW4808	614R	P04911	31491	48-00-5182	9202	-
L200ML2005	361345	S1122BF	DW4809	814R	P04927	31494	-	9205	-
L201ML1505	-	-	-	-	-	-	-	9202	-
L202ML1505	354792	S922EF	DW4811	618R	P04880	31454	48-00-5184	9201	-
L202ML2005	354793	S1122EF	DW4821	818R	P04933	31493	-	9204	-
L205ML1505	318127	S922HF	DW4806	610R	P46997	-	48-00-5092	9104	-
L205ML2805	-	-	-	-	P04983	-	-	9110	810R
L206ML3005	-	S1120CF	-	-	P46981	-	18-00-5710	-	960R

SAW BLADE SELECTION GUIDE

Materials

Jigsaw Blades

Ref.	All types of wood	Particle board covered	Agglomerate	Hard wood	Plywood	Rolled floor	Pallet	Windows	Wood with nails	Green wood	Plastics	Plastics reinforced with carbon fibres	Plexiglass	Varicor/ corian	Stainless steel	Tubes steel and shaped	Sheet metal	Non-ferrous metals	Aluminium	Frozen products
L000W	Optimal	Optimal	Optimal	Optimal	Optimal	Optimal														
L005W	Optimal	Optimal	Optimal	Optimal	Optimal	Optimal														
L008W	Optimal	Optimal	Optimal	Optimal	Optimal	Optimal														
L010W	Optimal	Optimal	Optimal	Optimal	Optimal	Optimal														
L011W	Optimal	Optimal	Optimal	Optimal	Optimal	Optimal														
L101W	Optimal	Optimal	Optimal	Optimal	Optimal	Optimal														
L002W	Optimal	Optimal	Optimal	Optimal	Optimal	Optimal					Occasional	Occasional		Occasional						
L003W	Optimal	Optimal	Optimal	Optimal	Optimal	Optimal					Occasional	Occasional		Occasional						
L001W	Optimal	Optimal	Optimal	Optimal	Optimal	Optimal					Occasional	Occasional		Occasional						
L004W	Optimal	Optimal	Optimal	Optimal	Optimal	Optimal					Occasional	Occasional		Occasional						
L006W	Optimal	Optimal	Optimal	Optimal	Optimal	Optimal					Occasional	Occasional		Occasional						
L007W	Optimal	Optimal	Optimal	Optimal	Optimal	Optimal					Occasional	Occasional		Occasional						
L009W	Optimal	Optimal	Optimal	Optimal	Optimal	Optimal					Occasional	Occasional		Occasional						
L100W	Optimal	Optimal	Optimal	Optimal	Optimal	Optimal					Occasional	Occasional		Occasional						
L012W	Optimal	Optimal	Optimal	Optimal	Optimal	Optimal					Occasional	Occasional		Occasional						
L012S									Optimal							Optimal	Optimal	Optimal	Optimal	
LMIX	Optimal	Optimal	Optimal	Optimal	Optimal	Optimal					Occasional	Occasional		Occasional	Optimal	Optimal	Optimal	Optimal	Optimal	Optimal
L000M															Optimal	Optimal	Optimal	Optimal	Optimal	Optimal
L001M															Optimal	Optimal	Optimal	Optimal	Optimal	Optimal
L002M															Optimal	Optimal	Optimal	Optimal	Optimal	Optimal
L003M															Optimal	Optimal	Optimal	Optimal	Optimal	Optimal
L004M											Optimal		Optimal		Optimal	Optimal	Optimal	Optimal	Optimal	Optimal
L005M											Optimal		Optimal		Optimal	Optimal	Optimal	Optimal	Optimal	Optimal

Reciprocating Blades

L200W	Optimal	Optimal	Optimal	Optimal	Optimal						Optimal									
L201W	Optimal	Optimal	Optimal	Optimal	Optimal						Occasional									
L202W	Optimal	Optimal	Optimal	Optimal	Optimal					Optimal										
L200S											Occasional									
L201S																				
L202S																				
L204S									Optimal	Optimal										
L205S																				Optimal
L206S																				
L200M															Optimal	Optimal	Optimal	Optimal	Optimal	Optimal
L201M															Optimal	Optimal	Optimal	Optimal	Optimal	Optimal
L202M															Optimal	Optimal	Optimal	Optimal	Optimal	Optimal
L205M															Optimal	Optimal	Optimal	Optimal	Optimal	Optimal
L203S										Optimal					Optimal	Optimal	Optimal	Optimal	Optimal	Optimal
L206M	Optimal	Optimal	Optimal	Optimal	Optimal	Optimal	Optimal	Optimal	Optimal	Optimal					Optimal	Optimal	Optimal	Optimal	Optimal	Optimal

Optimal Occasional

Materials

Benefits

Jigsaw Blades

Ref.	Cast iron	Sandwich panel	Tile	Plaster	Insulation materials	Rubber	Leather	Ceramic, tile	Cement fibre	Clean cutting	Rough cutting	Curved cutting	Perpendicular cutting	High-speed cutting	Reversed teeth	Long life
L000W										✓						✓
L005W										✓						
L008W										✓						
L010W										✓	✓					
L011W										✓	✓					
L101W										✓	✓					
L002W										✓						
L003W										✓					✓	
L001W										✓	✓					
L004W										✓						✓
L006W										✓						
L007W										✓			✓			
L009W										✓						
L100W										✓						
L012W										✓				✓		
L012S																✓
LMIX											✓			✓		✓
L000M																✓
L001M																✓
L002M		✓														✓
L003M		✓														✓
L004M																✓
L005M																✓

Reciprocating Blades

L200W				✓						✓						✓
L201W										✓			✓			✓
L202W										✓						✓
L200S					✓	✓	✓	✓		✓						✓
L201S	✓		✓					✓		✓						✓
L202S										✓						✓
L204S											✓					✓
L205S												✓		✓		✓
L206S			✓													✓
L200M										✓						✓
L201M										✓				✓		✓
L202M										✓				✓		✓
L205M										✓						✓
L203S										✓						✓
L206M										✓						✓

VIDEO DEMO



VIDEO DEMO



Ref.
L000W

Soft and hard wood 2,5-20 mm

Bi-metal jigsaw blade, long life.



Features

- Blade back with conical relief, inverted teeth, ground teeth.

Benefits

- Clean cut without splinters.
- Long service life due to bi-metal toothing.



Hard wood, Low density wood, Agglomerate, Rolled floor

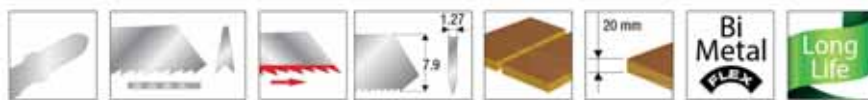

Qty	WL	TL	mm/tpi	Ref.	Gencod	Qty
5	55	80	1.90/13	L000W5	3336600177710	1

Carton card

Ref.
L005W

Soft and hard wood 2,5-35 mm

Jigsaw blade for scroll sawing.



Features

- Blade back with conical relief, ground teeth and double toothing.

Benefits

- Clean cut without splinters.
- Special scrollwork.

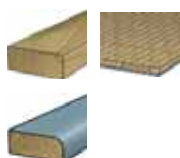

Low density wood, Rolled floor, Particle board covered



Qty	WL	TL	mm/tpi	Ref.	Gencod	Qty
5	75	100	2.5/10	L005W5	3336600177765	1

Carton card

Ref.
L008W

Soft and hard wood 2-40 mm

Jigsaw blade with inverted teeth for fast and clean cutting.



Features

- Blade back with conical relief, inverted teeth.

Benefits

- Fast and clean cut.
- For 2-40 mm melamine panels.



Low density wood, Agglomerate, Particle board covered

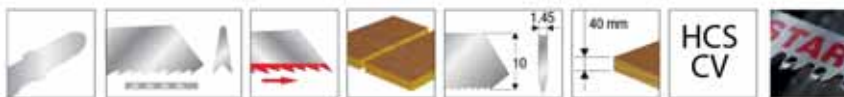

Qty	WL	TL	mm/tpi	Ref.	Gencod	Qty
5	91	117	1.90/13	L008W5	3336600177796	1

Carton card

Ref.
L010W

Soft and hard wood 5-50 mm

Special jigsaw blade for rough and fast cutting.



Features

- Teeth set, ground.

Benefits

- Fast and coarse cut.
- Ideal for all types of wood (5-50 mm).



Low density wood,
Wood



Qty	WL	TL	mm/tpi	Ref.	Gencod	Qty
5	75	100	4/6.35	L010WL1005	3336600177819	1
5	105	132	4/6.35	L010WL1325	3336600177826	1
5	155	180	4/6.35	L010WL1805	3336600177833	1

Carton card

Ref.
L011W

Soft and hard wood 5-50 mm

Special jigsaw blade for scroll sawing, rough and fast cutting.



Features

- Teeth set, ground, double toothed.

Benefits

- Fast and coarse cut.
- Ideal for all types of wood (5-50 mm).



Low density wood,
Wood



Qty	WL	TL	mm/tpi	Ref.	Gencod	Qty
5	75	100	4/6.35	L011W5	3336600177840	1

Carton card

Ref.
L101W

Soft and hard wood 5-50 mm

Black & Decker Jigsaw Blade for rough and fast cut.



Features

- Teeth set, ground.
- Compatible Black & Decker.

Benefits

- Fast, coarse cut, ideal for fast and coarse cut and edging.
- Ideal for all types of wood (5-50 mm).



Low density wood,
Wood



Qty	WL	TL	mm/tpi	Ref.	Gencod	Qty
5	75	100	4/6.35	L101W5	3336600177932	1

Carton card

Ref.
L002W

Wood and plastic 3-30 mm

Jigsaw blade for clean cuts.



Features

- Blade back with conical relief, ground teeth.

Benefits

- Clean cut.
- For all types of wood and plastic 3-30 mm.

Low density wood,
Wood, PlasticHCS
CV

Carton card

Qty	WL	TL	mm/tpi	Ref.	Gencod	Qty
5	75	100	2.5/10	L002W5	3336600177734	1
25	75	100	2.5/10	L002W25	3336600184886	1
100	75	100	2.5/10	L002W100	3336600185135	1

Ref.
L003W

Wood and plastic 3-30 mm

Jigsaw blade with inverted teeth for clean, splinter-free cutting.



Features

- Blade back with conical relief, inverted teeth, ground teeth.

Benefits

- Clean cut without splinters.
- For all types of wood and plastic 3-30 mm.

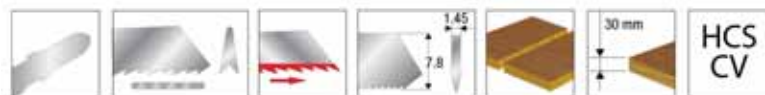
Low density wood,
Wood, PlasticHCS
CV

Carton card

Qty	WL	TL	mm/tpi	Ref.	Gencod	Qty
5	75	100	2.5/10	L003W5	3336600177741	1

Ref.
L001W

Wood and plastic 4-50 mm

Jigsaw blade for fast cutting.



Features

- Milled set teeth.

Benefits

- Effective on softwood and plastic (4-50mm).
- Fast cut.

Low density wood,
Agglomerate, PlasticHCS
CV

Carton card

Qty	WL	TL	mm/tpi	Ref.	Gencod	Qty
5	75	100	3/8.5	L001W5	3336600177727	1

Ref.
L004W

Wood and plastic 8-40 mm

Bi-metal jigsaw blade, long life.



Features

- Blade back with conical relief, ground teeth.



Low density wood,
Wood, Particle board
covered, Agglomerate,
plywood

Benefits

- Long service life due to bi-metal toothing.
- Fast and clean cut.
- Bi-metal teeth for longer life.



Qty	WL	TL	mm/tpi	Ref.	Gencod	Qty
5	75	100	3/8.5	L004W5	3336600177758	1

Carton card

Ref.
L006W

Wood and plastic 10-45 mm

Jigsaw blade for clean cut.



Features

- Blade back with conical relief, ground teeth.



Low density wood,
Wood, Plastic

Benefits

- Clean cut.
- All types of wood and plastic.

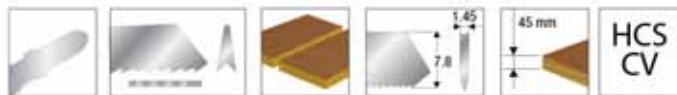

Qty	WL	TL	mm/tpi	Ref.	Gencod	Qty
5	75	100	2.5/6.35	L006W5	3336600177772	1
25	75	100	2.5/6.35	L006W25	3336600184923	1

Carton card

Ref.
L007W

Wood and plastic 10-45 mm

Jigsaw blade for fast cutting 90°.



Features

- Blade back with conical relief, ground teeth, thick blade.



Low density wood,
Wood, Plastic

Benefits

- Fast and clean cut at 90°.
- For hardwood, softwood, laminate, coated chipboard, plastic.

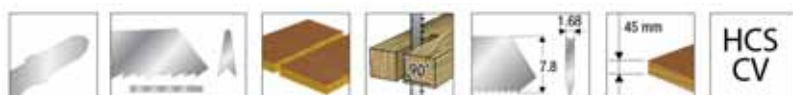

Qty	WL	TL	mm/tpi	Ref.	Gencod	Qty
5	75	100	4/6.35	L007W5	3336600177789	1

Carton card

Ref.
L009W

Wood and plastic 8-65 mm

Jigsaw blade, long length.



Features

- Blade back with conical relief, ground teeth, long blade.

Benefits

- Long and clean cut.
- Ideal for all types of wood, plastic (8-65 mm).

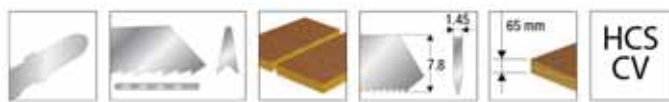
Low density wood,
Wood, Plastic

Qty	WL	TL	mm/tpi	Ref.	Gencod	Qty
5	105	132	3/8.5	L009W5	3336600177802	1

Carton card

Ref.
L100W

Wood and plastic 3-30 mm

Black & Decker clean cut jigsaw blade.



Features

- Blade back with conical relief, inverted teeth, ground teeth.
- Compatible Black & Decker.

Benefits

- Clean finish.

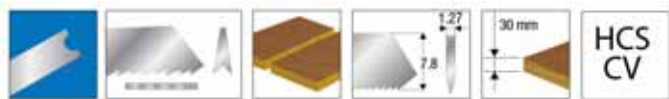
Low density wood,
Wood, Plastic

Qty	WL	TL	mm/tpi	Ref.	Gencod	Qty
5	75	100	2.5/10	L100W5	3336600177925	1

Carton card

Ref.
L012W

Composite material and perspex

Jigsaw blade for fast cutting 90°.



Features

- Blade back with conical relief, triple-ground teeth.

Benefits

- Clean and fast cutting.
- All kinds of wood and plastic.

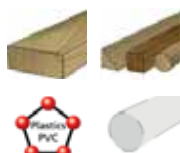
Low density wood,
Wood, Plastic, Plexi-
glass, Varicor Corian

Qty	WL	TL	mm/tpi	Ref.	Gencod	Qty
5	91	117	2.5/10	L012W5	3336600178243	1

Carton card

Ref.
L012S

Wood with nails

Bi-metal jigsaw blade, long life.



Features

- Milled, set teeth. Twincut teeth.
- Flexible blade.

Benefits

- Ideal for cutting pallets.
- Nailed wood <50 mm, metal 2.5-10 mm.

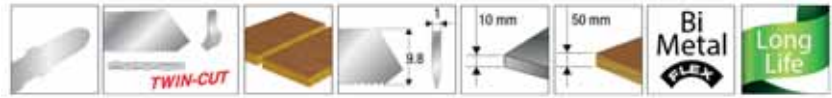

Wood with nails,
Tubes steel and
shaped



Qty	WL	TL	mm/tpi	Ref.	Gencod	Qty
5	91	116	1.3/13 6 2.0/19	L012S5	3336600177956	1

Carton card

Ref.
LMIX

Wood and steel

Set of 5 jigsaw blades.

Features

- Sheet: ref. L000M and L001M.
- Wood: ref. L010W, L001W and L002W.

Benefits

- This mixed wood and metal assortment covers many applications.



Qty	Ref.	Gencod	Qty
5	LMIX001	3336600177918	1

Carton card

Ref.
L000M

Steel, metal sheet and stainless steel

Jigsaw blade for extra fine materials.

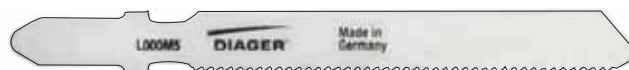

Features

- Milled, wavy teeth.
- Flexible blade.

Benefits

- Ideal for steel and stainless steel sheets, profiles (1.2 - 2 mm), and extra thin sheets.

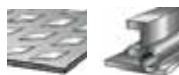

Sheet metal metal,
Tubes steel and
shaped, Stainless steel

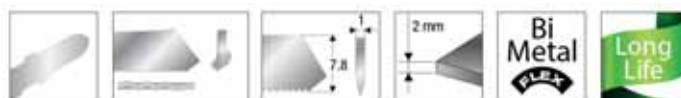

Qty	WL	TL	mm/tpi	Ref.	Gencod	Qty
5	55	76.5	1.2/21	L000M5	3336600177857	1
25	55	76.5	1.2/21	L000M25	3336600185036	1

Carton card

Ref.
L001M

Steel, metal sheet, copper and aluminium

Jigsaw blade for fine materials.



Features

- Milled, wavy teeth. Flexible blade.

Benefits

- Ideal for sheet metal, thin profiles, non-ferrous metals, aluminium (2.5-6 mm).



Tubes steel and shaped, Non-ferrous metal, Aluminium

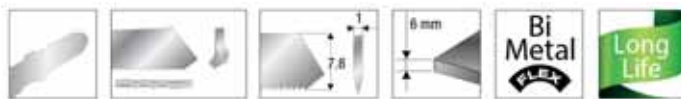

Qty	WL	TL	mm/tpi	Ref.	Gencod	Qty
5	55	76.5	2.0/13	L001M5	3336600177864	1
25	55	76.5	2.0/13	L001M25	3336600185043	1

Carton card

Ref.
L002M

Steel, metal sheet and stainless steel

Jigsaw blade for sandwich materials.



Features

- Milled, wavy teeth. Flexible and long blade.

Benefits

- Ideal for sandwich materials <80 mm.
- Steel and stainless steel sheets, profiles 1-3 mm.

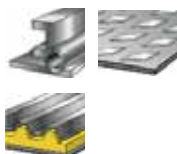

Tubes steel and shaped, Sheet metal, Sandwich panel

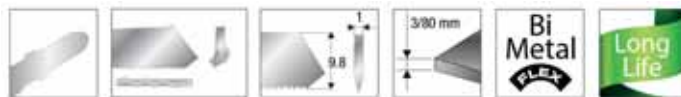

Qty	WL	TL	mm/tpi	Ref.	Gencod	Qty
5	105	132	1.0/25	L002M5	3336600177871	1

Carton card

Ref.
L003M

Steel and Copper

Jigsaw blade for sandwich materials.

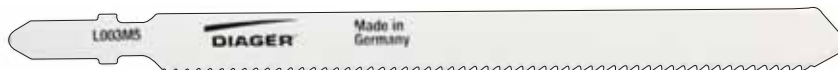

Features

- Milled, wavy teeth. Flexible and long blade.

Benefits

- Ideal for sandwich materials and copper.
- Suitable for steel profiles and pipes (2.5-6 mm), sandwich materials (<80 mm), non-ferrous metals.



Tubes steel and shaped, Sandwich panel, Non-ferrous materials

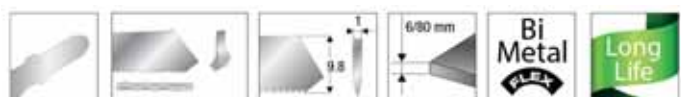

Qty	WL	TL	mm/tpi	Ref.	Gencod	Qty
5	105	132	1.8/14	L003M5	3336600177888	1

Carton card

Ref.
L004M

Aluminium, steel, plastic and copper

Special aluminium jigsaw blade.



Features

- Milled, set teeth. Flexible blade.

Benefits

- Ideal for aluminium, non-ferrous metals 3-15 mm, steel, plastics 3-30 mm.



Non-ferrous metal,
Aluminum, Stainless
steel

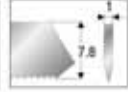

Carton card

Qty	WL	TL	mm/tpi	Ref.	Gencod	Qty
5	75	100	3/8.5	L004M5	3336600177895	1

Ref.
L005M

Stainless steel, steel and metal sheet

Jigsaw blade with carbide teeth.



Features

- Carbide bar teeth, ground teeth.

Benefits

- Ideal for steel, sheet metal, stainless steel (1.5 - 3.0 mm).

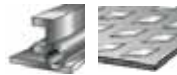

Tubes steel and
shaped, Sheet metal,
Stainless steel

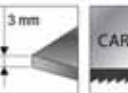
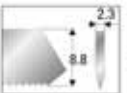

Carton card

Qty	WL	TL	mm/tpi	Ref.	Gencod	Qty
2	50	79	1.0/1.0	L005M2	3336600177901	1





Ref.
L200W

Plaster, wood and plastic

Special plaster reciprocating saw blade.



Features

- Milled set teeth.

Benefits

- Ideal for gypsum and fibre cement boards.



Low density wood,
Wood, Plastic, Plas-
ter, Cement fibre

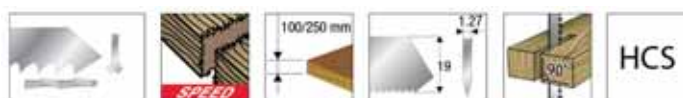

Qty	WL	TL	mm/tpi	Ref.	Gencod	Qty
5	130	150	4.2/6	L200WL1505	3336600177963	1
25	130	150	4.2/6	L200WL15025	3336600184428	1
100	130	150	4.2/6	L200WL150100	3336600184640	1
5	280	300	4.2/6	L200WL3005	3336600177970	1

Quality plastic pouch

Ref.
L201W

Wood and plastic

Reciprocating saw blade fast cutting.



Features

- Milled set teeth.
- Flexible blade.

Benefits

- Ideal for composite materials.
- Fast cut.
- All types of wood, plastic, composite materials (6-100 mm).



Low density wood,
Wood, Plastic



Qty	WL	TL	mm/tpi	Ref.	Gencod	Qty
5	130	150	4.2/6	L201WL1505	3336600177987	1
5	205	225	4.2/6	L201WL2255	3336600177994	1

Quality plastic pouch

Ref.
L202W

Green wood

Reciprocating saw blade with reinforced teeth.



Features

- Ground and heat-strengthened set of teeth.

Benefits

- Ideal for green wood.
- Suitable for green wood, logs (<190 mm).



Green wood

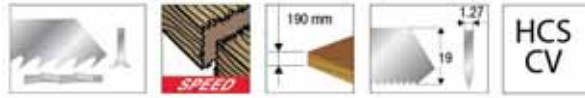

Qty	WL	TL	mm/tpi	Ref.	Gencod	Qty
5	220	240	6.35/5-4/5	L202WL2405	3336600178007	1

Quality plastic pouch

Ref.
L200S

Insulation material

Double sharpening reciprocating saw blade.



Features

- Knife blade with double corrugated sharpening.

Benefits

- Specifically designed for insulating materials.
- Clean and fast cutting.
- Suitable for : insulation materials, cardboard, leather, rubber (<250 mm).



Insulation material,
Leather, Rubber, Paper-
board, Insulation material

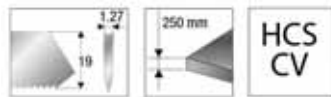

Qty	WL	TL	Ref.	Gencod	Qty
2	280	300	L200SL3002	3336600178137	1

Quality plastic pouch

Ref.
L201S

Cast iron, brick and ceramic

Reciprocating saw blade diamond teeth.



Features

- Blade with diamond concretion.

Benefits

- Special for cast iron, brick and earthenware.
- Long service life.

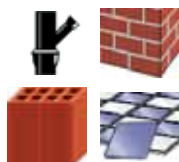

Cast iron, Brick,
Tile, Hollow brick,
Ceramic tile



Qty	WL	TL	Ref.	Gencod	Qty
1	180	200	L201SL2001	3336600178144	1

Quality plastic pouch

Ref.
L202S

Stainless steel, steel and plastic

Reciprocating saw blade carbide teeth.



Features

- Carbide tipped bar.
- Ground teeth.

Benefits

- Clean cut.
- Suitable for : Stainless steel, sheet metal, pipes, plexiglass, composite materials.



Stainless steel, Sheet metal, Tubes steel and shaped, Plastics, reinforced, Plexiglass



Qty	WL	TL	mm/tpi	Ref.	Gencod	Qty
2	95	115	1.4/18	L202SL1152	3336600178151	1

Quality plastic pouch

Ref.
L204S

Palet and wood with nails

Reciprocating saw blade COMBO teeth.



Features

- Milled, set teeth, variable tooth pattern. Flexible blade.

Benefits

- Suitable for : wood with nails, sheet metal, pipes, aluminium, non-ferrous metals.



Wood with nails, Tubes steel and shaped, Pallets



Qty	WL	TL	mm/tpi	Ref.	Gencod	Qty
5	130	150	2.5-1.8/10/14	L204SL1505	3336600178014	1
100	130	150	2.5-1.8/10/14	L204SL150100	3336600184831	1
5	205	225	2.5-1.8/10/14	L204SL2255	3336600178021	1
5	250	280	2.5-1.8/10/14	L204SL2805	3336600178038	1

Quality plastic pouch

Ref.
L205S

Ice

Reciprocating saw blade stainless steel.



Features

- Stainless steel blade.
- Milled set teeth.

Benefits

- Ideal for frozen products and ice cream up to 250/350 mm.

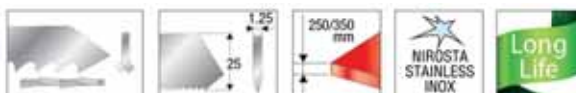

Frozen products



Qty	WL	TL	mm/tpi	Ref.	Gencod	Qty
1	280	300	6.35/4	L205SL3001	3336600185913	1

Quality plastic pouch

Ref.
L202M

Steel, metal sheet and stainless steel

Reciprocating saw blade for fine materials.



Features

- Teeth wavy, milled.
- Flexible blade.

Benefits

- Ideal for sheet metal, thin pipes and stainless steel (1.5-2.5mm).

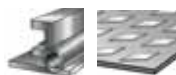

NIROSTA

STAINLESS

INOX

Tubes steel and
shaped, Sheet metal,
Stainless steel

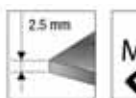
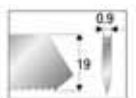

Qty	WL	TL	mm/tpi	Ref.	Gencod	Qty
5	130	150	1.4/18	L202ML1505	3336600178076	1
5	180	200	1.4/18	L202ML2005	3336600178083	1

Quality plastic pouch

Ref.
L205M

Steel, stainless steel and copper

Reciprocating saw blade for thick materials.



Features

- Milled set teeth.
- Flexible blade.

Benefits

- Ideal for thick sheets and pipes (3-12mm).
- High durability.



Cu, Ni,

ML, Zn

Tubes steel and
shaped, Non-ferrous
materials

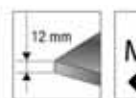
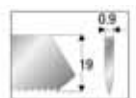

Qty	WL	TL	mm/tpi	Ref.	Gencod	Qty
5	130	150	2.5/10	L205ML1505	3336600178113	1
5	260	280	2.5/10	L205ML2805	3336600178120	1

Quality plastic pouch



Ref.
L203S

Steel, metal sheet, copper and wood with nails

Reciprocating saw blade Twin-cut teeth.



Features

- Milled set teeth.
- Twincut teeth and flexible blade.

Benefits

- Ideal for pipes and profiles.
- Ideal for wood with nails.



Tubes steel and shaped,
Non-ferrous materials,
Aluminum, Sheet metal

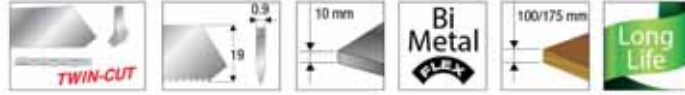

Qty	WL	TL	mm/tpi	Ref.	Gencod	Qty
5	130	150	2.5-1.8/10/14	L203SL1505	3336600178168	1
5	205	225	2.5-1.8/10/14	L203SL2255	3336600178175	1

Quality plastic pouch

Ref.
L206M

Steel, metal sheet, copper and wood with nails

Reciprocating saw blade for demolition.



Features

- Milled and corrugated teeth. Very thick blade for straight cuts.

Benefits

- Ideal for demolition/renovation work in metal, wood, studded wood.



Tubes steel and
shaped, Wood, Wood
with nails

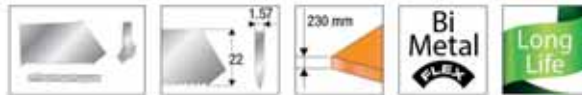

Qty	WL	TL	mm/tpi	Ref.	Gencod	Qty
5	280	300	2.5/10	L206ML3005	3336600185937	1

Quality plastic pouch



TEXTILE



LONG SLEEVES POLO



SHORT SLEEVES POLO



DOWN JACKET



HOODED JACKET



SOFTSHELL JACKET



SLEEVELESS SOFTSHELL



BODYWARMER



CAP



SHORT SLEEVES T-SHIRT



HAT

Features

Ref.

DIAGER HAT	GDBBONNET
DIAGER CAP	GDBCASQUETTE
DIAGER SHORT SLEEVES T-SHIRT, SIZE M	GDBTSM
DIAGER SHORT SLEEVES T-SHIRT, SIZE L	GDBTSL
DIAGER SHORT SLEEVES T-SHIRT, SIZE XL	GDBTSXL
DIAGER LONG SLEEVES T-SHIRT, SIZE S	GDBTSMLS
DIAGER LONG SLEEVES T-SHIRT, SIZE M	GDBTSMLM
DIAGER LONG SLEEVES T-SHIRT, SIZE L	GDBTSMLL
DIAGER LONG SLEEVES T-SHIRT, SIZE XL	GDBTSMLXL
DIAGER LONG SLEEVES T-SHIRT, SIZE XXL	GDBTSMLXXL
DIAGER SHORT SLEEVES POLO, SIZE S	GDBPOLOS
DIAGER SHORT SLEEVES POLO, SIZE M	GDBPOLOM
DIAGER SHORT SLEEVES POLO, SIZE L	GDBPOLOL
DIAGER SHORT SLEEVES POLO, SIZE XL	GDBPOLOXL
DIAGER SHORT SLEEVES POLO, SIZE XXL	GDBPOLOXXL
DIAGER LONG SLEEVES POLO, SIZE S	GDBPOLOMLS
DIAGER LONG SLEEVES POLO, SIZE M	GDBPOLOMLM
DIAGER LONG SLEEVES POLO, SIZE L	GDBPOLOMLL
DIAGER LONG SLEEVES POLO, SIZE XL	GDBPOLOMLXL
DIAGER LONG SLEEVES POLO, SIZE XXL	GDBPOLOMLXXL
DIAGER SLEEVELESS SOFTSHELL, SIZE S	GDBSOFTSHELLS
DIAGER SLEEVELESS SOFTSHELL, SIZE M	GDBSOFTSHELLM
DIAGER SLEEVELESS SOFTSHELL, SIZE L	GDBSOFTSHELLL
DIAGER SLEEVELESS SOFTSHELL, SIZE XL	GDBSOFTSHELLXL
DIAGER SLEEVELESS SOFTSHELL, SIZE XXL	GDBSOFTSHELLXXL
DIAGER BODYWARMER, SIZE S	GDBBODYWARMS
DIAGER BODYWARMER, SIZE M	GDBBODYWARMM
DIAGER BODYWARMER, SIZE L	GDBBODYWARML
DIAGER BODYWARMER, SIZE XL	GDBBODYWARMXL
DIAGER BODYWARMER, SIZE XXL	GDBBODYWARMXXL
DIAGER SOFTSHELL JACKET, SIZE S	GDBVESTES
DIAGER SOFTSHELL JACKET, SIZE M	GDBVESTEM
DIAGER SOFTSHELL JACKET, SIZE L	GDBVESTEL
DIAGER SOFTSHELL JACKET, SIZE XL	GDBVESTEXL
DIAGER SOFTSHELL JACKET, SIZE XXL	GDBVESTEXXL
DIAGER HOODED JACKET, SIZE S	GDBVESTECAPS
DIAGER HOODED JACKET, SIZE M	GDBVESTECAPM
DIAGER HOODED JACKET, SIZE L	GDBVESTECAPL
DIAGER HOODED JACKET, SIZE XL	GDBVESTECAPXL
DIAGER HOODED JACKET, SIZE XXL	GDBVESTECAPXXL
DIAGER DOWN JACKET, SIZE S	GDBDOUDOUNES
DIAGER DOWN JACKET, SIZE M	GDBDOUDOUNEM
DIAGER DOWN JACKET, SIZE L	GDBDOUDOUNEL
DIAGER DOWN JACKET, SIZE XL	GDBDOUDOUNEXL
DIAGER DOWN JACKET, SIZE XXL	GDBDOUDOUNEXXL

INFORMATION SHOP



Ref. GORIDIAGER

Ref. M00195



Features

Ref.

DIAGER INFLATABLE TENT 3X3	M00174
DIAGER ARCH	M00195
DIAGER BEACH FLAG	GORIDIAGER
DIAGER BANNER	B00503
DIAGER TABLECLOTH	M00187
DIAGER POSTER	D00320
BOOSTER PLUS POSTER	D00311
ULTIMAX 646 POSTER	D00310
SPEEDUSTER POSTER	D00306
BOOSTER 113 POSTER	D00313
KAKEMONO ULTIMAX646 FR	M00172
KAKEMONO SPEEDUSTER FR	M00183



Ref. D00311



Ref. D00310



Ref. B00503

DRILL CENTER

A SPECIFIC SPACE DESIGNED FOR DIAGER PRODUCTS

The aim of the DRILL CENTER is to distinguish the products geographically and visually in selling location. The concept is composed of several sales shelf forming a sales pole chartered, the customer then visualizes the entire product range DIAGER.

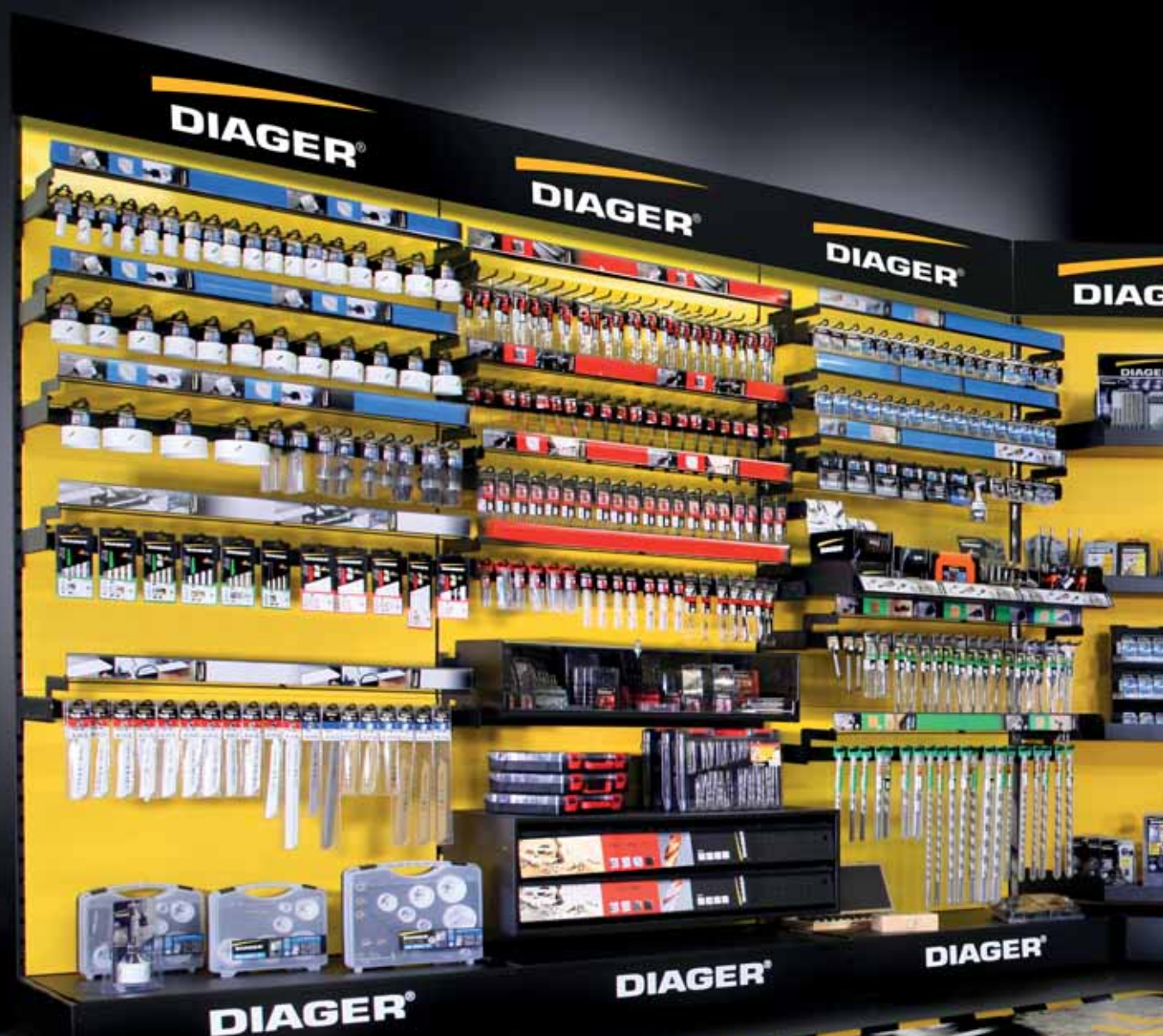

Features	Ref.	Gencod
CORNER	GONDCORNER	3336609008671
SHELF FOR CORNER	M00193	3336609008688
NEXT SALES SHELF 1M (to attribute with the pediment of your choice)	GOND1001	3336609000033
DIAGER LUMINAR PEDIMENT FOR GOND1001	M00202	3336609009500
ELECTRIC CABLE FOR LUMINAR PEDIMENT (to attribute with each command of pediment)	CORDON	3336600187528

Accessories of presentation (rack, showcase, shelf ...) the same to those used on high sales shelf.
Background Golden yellow sales shelf coated in material backgrounds.

6 METERS DISPLAY

A COMPLETE RANGE OF ELECTROPORTATIVE ACCESSORIES



CONCEPT STORE

DRILLING SPECIALIST

Planograms including Concrete drilling ranges, Accessories



0.5 M CONCRETE SPECIALIST



1 M CONCRETE SPECIALIST



2 M CONCRETE SPECIALIST



1 M WOOD RANGE



1 M METAL RANGE



1 M SAWING AND SCREW BITS RANGE

ADDITIONAL RANGES



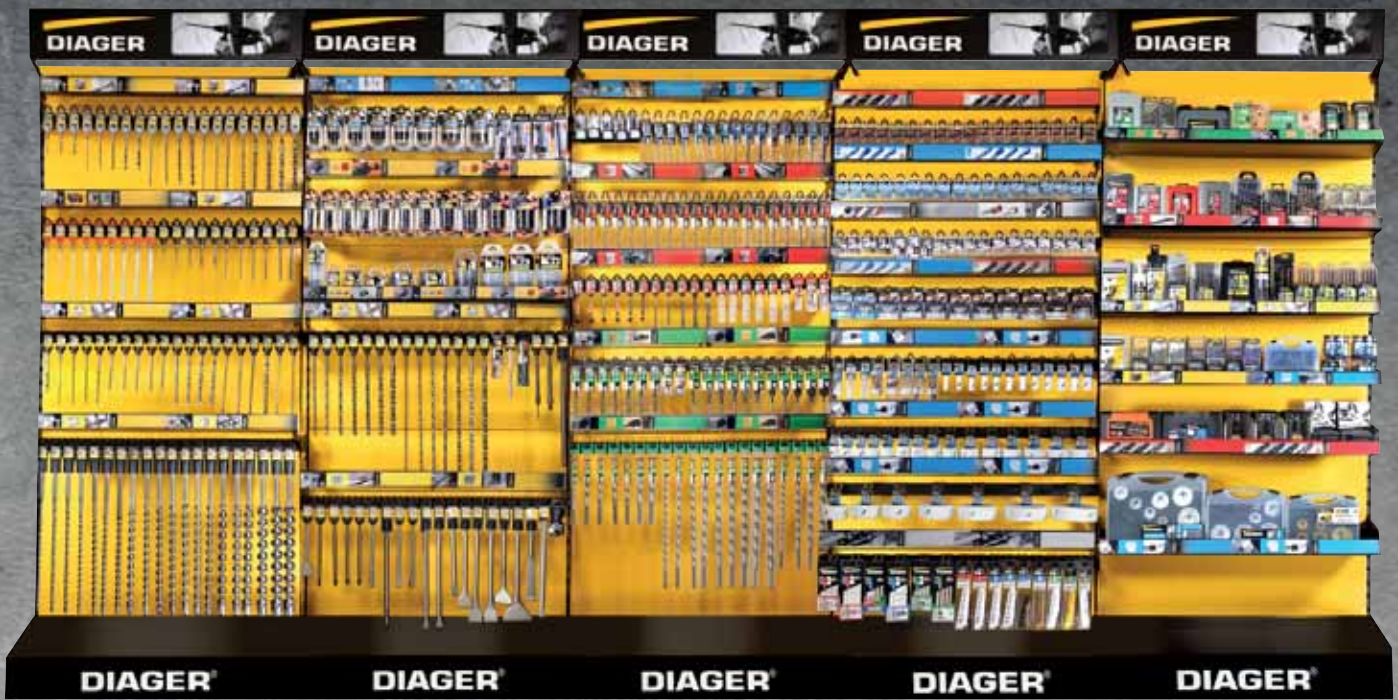

GENERALIST ALL PRODUCTS

Planograms including drilling ranges
Concrete, Metal, Wood, Accessories,
Sawing and Screw bits



DRILLING GENERALIST



2 M GENERALIST RANGE
ALL PRODUCTS



1 M GENERALIST



2 M GENERALIST

STORE CONCEPT LOW SALES SHELF



LOW SALES SHELF ISLAND, FRONT-BACK, Delivered in kit to assemble

Allows positioning in the "low" areas of the Self-Service Presentation accessories (rack, showcase, shelf...) identical to those used on the high sales shelf.

The kit includes : 1 base on wheels, 1 welcoming metal structure 2 bottom grids. Possibility to dress the grids with the magnetic yellow gold Funds (to be positioned on the metal structure, location foreseen).

Features	Ref.	Gencod
LOW SALES SHELF STRUCTURE FRONT-BACK	M00188	3336609008312
DIAGER PEDIMENT	M00189	3336609008329
DIAGER REMOVABLE SIDEBAND	M00190	3336609008336
SALES SHELF HEAD FOR LOW SALES SHELF	M00192	3336609008701

ANIMATION SALES



PROMO DISPLAY PERMED

LOW SALES SHELF ISLAND, FRONT- BACK, Delivered assembled

To animate your sales, mobile display that can be put in place in sales shelf t head gold in the middle of the shop. Product implementation in front and back on hooks and shelves. Fixed showcase with lock. Supplied accessories: 30 hooks and 2 shelves. (Pediment marks to put).



Features

Ref.

Gencod

P.O.S ADVERTISING CONCEPT

M00161

3336609006035

LIST OF FURNITURE

Features	Ref.	Gencod	Visual
1M SALES SHELF (to attribute with the pediment of your choice)	GOND1000	3336609000019	1
1M SALES SHELF to be connected with GOND1000 (to attribute with the pediment of your choice)	GOND1001	3336609000033	-
0,5M SALES SHELF (to attribute with the pediment of your choice)	GOND500	3336609000071	-
LUMINAR PEDIMENT FOR GOND1000/1 (to attribute with the banner, see list of your choice)	M00202	33366090009500	2
LUMINAR PEDIMENT FOR GOND500 (to attribute with the banner, see list of your choice)	M00203	33366090009975	3
ELECTRIC CABLE FOR LUMINAR PEDIMENT (to attribute with each command of pediment / 1 only by command even if several pediments)	CORDON	3336600187528	4
DIAGER PEDIMENT FOR GOND1000/1	FR1000	3336609005472	5
DIAGER PEDIMENT FOR GOND 500	FR500	3336609005373	6
BOX WITH WHEELS 1M	M00124	3336609004253	7
BOX 1M BLACK	M00185	3336609008220	8
BOX 1,33M YELLOW	M00127	3336609007322	-
YELLOW PERFORATED WIDTH 1M	TOLEPERF	3336609008282	9
LAYING OUT LOW OF SALES SHELF 1M	M00145	3336609005731	10
ADJUSTABLE RACK 1M 20 DOUBLE HOOKS	RAT1000DOUBLE	3336609002211	11
ADJUSTABLE RACK 0,5M 10 DOUBLE HOOKS	RAT500	3336609000088	12
ADJUSTABLE RACK WITHOUT HOOKS 1M (to attribute with hooks M00151-2, max 17)	M00150	3336609004468	13
ADJUSTABLE RACK WITHOUT HOOKS 1,33M (to attribute with hooks M00151-2, max 26)	M00159	3336609005984	-
ADJUSTABLE RACK WITHOUT HOOKS 0,50M (to attribute with hooks M00151-2, max 10)	M00158	3336609005793	-
DOUBLE HOOK 1M/0.5ML	M00151	3336609004468	14
SIMPLE HOOK 1M/0.5ML	M00152	3336609004475	15
ANTI-THEFT 1M	ANTIVOL1000	3336609002037	16
ANTI-THEFT 0,5M	ANTIVOL500	3336609004291	-
ANTI-THEFT FOR HOOK	M00169	3336609006745	17
SUPPORT FOR BAR FOR REMOVABLE HOOK PE 500	SPE500	3336609000101	18
SHELF FOR SETS 0,5M (to attribute with 1 BAR1000)	SCOFF	3336609000064	19
ADJUSTABLE SHELF WIDTH 900 mm DEPTH 360 mm	M00167	3336609006141	20
ADJUSTABLE SHELF WIDTH 1250 mm DEPTH 360 mm	M00168	3336609006158	-
ADJUSTABLE SHELF WIDTH 0,5M	TAB500400	3336609000170	-
STORAGE UNIT WITH 2 DRAWERS (to attribute with 2 BAR1000)	M00170	3336609006806	21

Features	Ref.	Gencod	Visual
DISPLAY CASE (to attribute with 1 BAR1000)	M00157	3336609005274	22
1M STAY FOR 1M SALES SHELF	BAR1000	3336609000057	23
1,33M STAY FOR 1,33M SALES SHELF	BAR1300	3336609000125	-
0,5M STAY FOR 0,5M SALES SHELF	BAR500	3336609000095	24
REVOLVING DISPLAY (to attribute with X hooks M00139)	M00129	3336609004352	25
BRACKET for installation on rack	M00204	3336609010476	-
STAND FOR REVOLVING DISPLAY	M00130	3336609004369	27
BRACKET FOR REVOLVING DISPLAY (to attribute with 2 BAR1000)	M00137	3336609004376	26
PIN FOR PERFORATED METAL SHEET	M00113	3336609000620	28
HOOK FOR CONSUMER INFORMATION	STOPRAYON	3336609000149	29
PR 24 DISPLAY - STRUCTURE ONLY (delivered flat)	M00135	3336609007643	30
6 HOOKS RACK	M00101	3336609008640	31
RACK SYSTEM FOR PR24 STRUCTURE	M00102	3336609007650	-
HOOK FOR M00102 RACK SYSTEM	M00103	3336609007339	-
COMMUNICATION KIT DIAGER (pediment + Sideband)	M00107	3336609008657	-
MONOBLOC DISPLAY - STRUCTURE ONLY	M00171	3336609006844	-
HOOK FOR CORE BIT 1/2	M00122	3336609004338	32
HOOK FOR CORE BIT 1-1/4	M00123	3336609004345	33
HOOK FOR DIAMOND DISK (to attribute with 1 BAR1000 for max.8)	M00118	3336609004307	34
ANTI-THEFT FOR DIAMOND DISK	M00119	3336609004314	35
BIN WITH REMOVAL DIVIDER (Width 500 mm x Depth 500 mm)	M00197	3336609008909	-
DISPLAY HSS COUNTER	M00087	3336609000194	36
STAND COUNTER (delivered with 2 shelfies)	C00085	3336609005397	37
HOOK FOR STAND COUNTER C00085 (9 per display max)	C00087	3336609005670	38
CARDBOARD P.O.S FOR SETS PRESENTATION	C00107	3336609007308	39
CARPET 1ML	M00184	3336609008169	-
SCREWBITS BOX BULK	M00120	3336609001306	-
BACK DIAGER HOOK (PCB 50)	M00140	3336609003171	-
DIAGER MAGNET	B00404	3336609004437	-
YELLOW BACKGROUND 1ML	B00508	3336609008770	-
YELLOW BACKGROUND 1,33ML	B00509	3336609008787	-

*Declined in several formats



1 *



Window display



Down and up box



Background



Modular stand



Shelf



Racks



Anti-theft



Stay for sales shelf and hooks



Special core bit

Revolving display

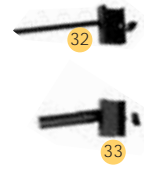

Various



CUSTOMER SERVICE

+33 (0)3 84 73 78 42

8H00 to 12H30 & 13h30 to 17h30



PRODUCT EXPERTISE

Diager provides you with all of its human and technical resources.

DIAGER Experts:

- Analyse products problems.
- Provide new solutions.
- Intervene on the sites.



TRAINING

Technical skill is necessary for our shared success, so that's why DIAGER's teams are available to help you on a daily basis, advise you and provide theory and practical training sessions.



ASSISTANCE ON SITE

Our team of sales promoters are with you on-site every step of the way to help you with the technical and specific requests of your customers. In the field, they will help you choose the most suitable product for your applications and offer advice and demonstrations on tools.

DIAGER reserves the sale of its products to professional distributors according to its general terms and conditions of sale that comply with article L 441-7 of the Code of Mercantile law. The data contained in this catalogue are those known upon its date of publication and are subject to change. Photographs are non-binding.

Diager uses PEFC certified paper for catalog printing.

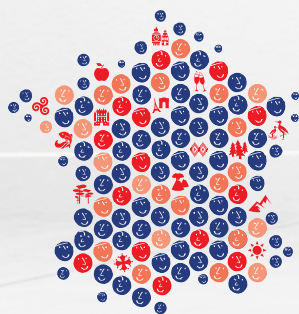

**IMPRIMÉ
EN FRANCE**
**AU CŒUR
DE NOS RÉGIONS**



FIND US ON SOCIAL MEDIA



FOLLOW US !

INSTAGRAM

@diager_official

FACEBOOK

facebook.com/diagersas/

LINKEDIN

linkedin.com/company/diager/



*find all the videos
on our chain*

You 





DIAGER[®]

PROFESSIONAL TOOLS MANUFACTURER

FOLLOW US !



INSTAGRAM
[@diager_official](#)



FACEBOOK
[facebook.com/diagersas](#)



LINKEDIN
[linkedin.com/company/diager](#)



YOUTUBE



Rue Henri Moissan
BP 90149
39802 POLIGNY Cedex 2
FRANCE

Tel. +33 (0)3 84 73 74 75

Fax +33 (0)3 84 73 74 76

contact@diager.com